

Tarif

2026



Aide à la consultation



TARIF INTERACTIF

Tout à portée de clic

1. Cliquez sur les sections du **sommaire** pour y **accéder directement**

MODULAR COOKING ICON7000 →

2. Cliquez sur la **référence commerciale** pour accéder directement à la **page Web du produit**

OSOFAO →

3. Cliquez et **retournez au sommaire** →

4. Cliquez et **retournez au début de la section** →

SYMBOLES



Dimensions LxPxH



Alimentation Gaz



Alimentation Électrique



Branchements Électriques



Produit disponible uniquement pour les pays hors Communauté Européenne.



Produit connectable au portail APO.LINK dès sortie d'usine



Produit pre-equipé pour groupe frigorifique à distance



Années de garantie sur les pièces de détachées

Contactez nos bureaux pour plus d'informations, pour la garantie, veuillez vous référer aux conditions standard.

ALIMENTATION GAZ

Les appareils sont testés au gaz naturel ou au gaz type GPL selon la commande.

ALIMENTATION ÉLECTRIQUE

Les tensions et les fréquences des appareils sont conformes à la norme européenne EN. Pour la disponibilité d'autres tensions, fréquences et devis correspondants, consulter l'entreprise.

Conformément au règlement 517/2014 F-GAS les produits refroidissants qui contiennent des fluides HFC sont soumis aux dispositions du Protocole de Kyoto. Le GWP des fluides HFC est supérieur à 150.

Sommaire

SOCIÉTÉ	5
---------------	---

Cuisson

CUISSON MODULAIRE ICON7000	
CUISSON MODULAIRE ICON9000 2MM	
CUISSON MODULAIRE ICON9000 PLUS 3MM	
CUISSON AVEC PLAN DE TRAVAIL UNIQUE MONOLITHE	

Fours

FOURS - INTRODUCTION	
FOURS MIXTES ACT.O	
FOURS MIXTES TAST.O	
FOURS MIXTES PRACTICO	
ACCESSOIRES FOURS MIXTES	
ACCESSOIRES FOURS MIXTES - TRAITEMENT DE L'EAU	
ACCESSOIRES FOURS MIXTES - PRODUITS LESSIVIELS	
SALAMANDRE	

Appareils multifonctions

MULTIFONCTIONS FROID/CHAUD ARI.O	
--	--

Froid

CELLULES DE REFROIDISSEMENT RAPIDE - INTRODUCTION	
CELLULE MIXTE REFROIDISSEMENT RAPIDE AVEC DES FONCTIONS SPÉCIALES IDE.O	
CELLULES MIXTES DE REFROIDISSEMENT RAPIDE CHILLSTAR ECO+	
CELLULES MIXTES AVEC DES FONCTIONS SPÉCIALES BLITZ ROLL-IN	
ACCESSOIRES POUR CELLULES MIXTES DE REFROIDISSEMENT RAPIDE	
ARMOIRES FRIGORIFIQUES - INTRODUCTION	
ARMOIRES FRIGORIFIQUES X-CEL	
ARMOIRES FRIGORIFIQUES X-TRA PLUS	
ARMADI FRIGORIFERI QSR	
ARMOIRES FRIGORIFIQUES FREE-GO PLUS	
ARMOIRES FRIGORIFIQUES ROLL-IN	
BANQUES RÉFRIGÉRÉES - INTRODUCTION	
BANQUES RÉFRIGÉRÉES DIV.A PROFONDEUR 70 CM GN 1/1	
BANQUES RÉFRIGÉRÉES DIV.A PROFONDEUR 60 CM	
BANQUES RÉFRIGÉRÉES VOICE	
CHAMBRES FROIDES	
MACHINES À GLAÇONS	

Ligne Pizza

LIGNE PIZZA - INTRODUCTION	
FOURS À PIZZA, SUPPORTS ET CHAMBRES DE POUSSE	
SALADETTE	

Pâtisserie et Crème Glacée

PÂTISSERIE ET CRÈME GLACÉE - INTRODUCTION
ARMOIRES DE FERMENTATION CONTRÔLÉE
ARMOIRES FRIGORIFIQUES
BANQUES RÉFRIGÉRÉES
ARMOIRES FRIGO CONSERVATION CRÈME GLACÉ
CELLULE DE SURGELATION RAPIDE CRÈME GLACÉE

Exposition

VITRINES VERTICALES RÉFRIGÉRÉES EMPIRE
--	-------

Préparation

PRÉPARATION - INTRODUCTION
PRÉPARATION MASTER 700
PRÉPARATION MASTER 600
ÉLÉMENTS COMPLÉMENTAIRES
APPAREILS MÉCANIQUES

Distribution

DISTRIBUTION - INTRODUCTION
SELF-SERVICE EN LIGNE
ÉLÉMENTS DROP-IN
CHARIOTS

Laverie

LAVERIE FRONTALE - INTRODUCTION
LAVE-VAISSELLE SÉRIE KE
LAVE-VAISSELLE SÉRIE KLE
LAVE-VAISSELLE SÉRIE KNE
LAVE-OBJECTS SÉRIE LPE
ACCESSOIRES LAVE-VAISSELLE
LAVE-VAISSELLE À AVANCEMENT AUTOMATIQUE DU PANIER SÉRIE TE

Ventilation

VENTILATION - INTRODUCTION
VENTILATION - SÉRIE ECO
VENTILATION - SÉRIE PLUS
MOTEURS D'ASPIRATION - DE VENTILATION



Angelo Po, pour toute *la* cuisine

Une cuisine est bien plus qu'un lieu de travail. C'est un laboratoire d'idées, un espace de relations où la précision et l'efficacité prennent tout leur sens lorsqu'elles réussissent à générer des expériences inoubliables.

Depuis 100 ans, Angelo Po concilie performance et beauté en proposant des solutions et des esthétiques modernes, basées sur des intuitions continues qui reposent sur un engagement sincère envers la durabilité et sur une écoute active du client.

Des lignes de cuisson horizontales

et verticales aux systèmes pour la conservation des aliments, Angelo Po conçoit et produit des installations complètes pour la restauration professionnelle, en imaginant des solutions et des services qui transforment, dès le premier jour, la cuisine en lieu d'expression par excellence et de créativité.

Angelo Po fait partie de Marmon Foodservice Technologies, groupe de la holding américaine Berkshire Hathaway Inc. L'entreprise se targue d'une présence internationale avec plusieurs filiales à l'étranger et un réseau commercial tentaculaire.

 **ANGELO PO**

Made in Italy 



Une large gamme de certifications à la disposition de nos clients

CERTIFICATIONS D'ENTREPRISE



ISO 9001
Certification d'entreprise du système de qualité.



ISO 14001
Certification d'entreprise du système de gestion ambiante.



ISO 45001
Certification d'entreprise du système de gestion de la sécurité et de la santé au travail.



EAC: elle garantit le respect aux réquisits de sécurité et de protection de la santé des citoyens, en conformité aux normes russes.



ETL: applicable au marché nord-américain (Etats-Unis et Canada), elle garantit la conformité aux normes de sécurité des Etats-Unis et Canada.

CERTIFICATIONS DE PRODUIT

Consultez le site Web ou contactez le fabricant pour plus de détails sur les produits.



AGA: applicable au marché australien, elle garantit la conformité aux normes de sécurité de l'Australie.



IAPMO: applicable au marché australien, elle garantit la conformité aux normes de sécurité de l'Australie.



BELGAQUA: applicable au marché du Belgique. Elle garantit la conformité aux règles de sécurité relatives au réseau hydraulique. Elle prévient des risques de dépression susceptibles de polluer ou d'endommager le réseau.



KGS: elle garantit le respect aux réquisits de sécurité et de protection de la santé des citoyens, en conformité aux normes coréennes.



CB SCHEME: elle garantit la conformité des composants électriques et électroniques aux normes de sécurité internationales IEC.



KIWA: applicable au marché du Royaume-Uni. Elle garantit la conformité aux règles de sécurité relatives au réseau hydraulique. Elle prévient des risques de dépression susceptibles de polluer ou d'endommager le réseau.



CE: la certification CE garantit le respect et la conformité aux normes de sécurité pour les produits mis sur le marché de l'UE.



NSF: applicable au marché nord-américain (Etats-Unis et Canada), elle garantit la conformité aux normes d'hygiène définies par ENF/ANSI.



CSQA: applicable au marché européen, elle garantit le respect et la conformité des appareils de cuisson modulaire aux normes sur la conception hygienique.



WATERMARK: applicable au marché australien. Elle garantit la conformité aux règles de sécurité relatives au réseau hydraulique. Elle prévient des risques de dépression susceptibles de polluer ou d'endommager le réseau.

APO.LINK & INDUSTRY 4.0

Connectez les produits au portail APO.LINK et découvrez d'innombrables avantages !

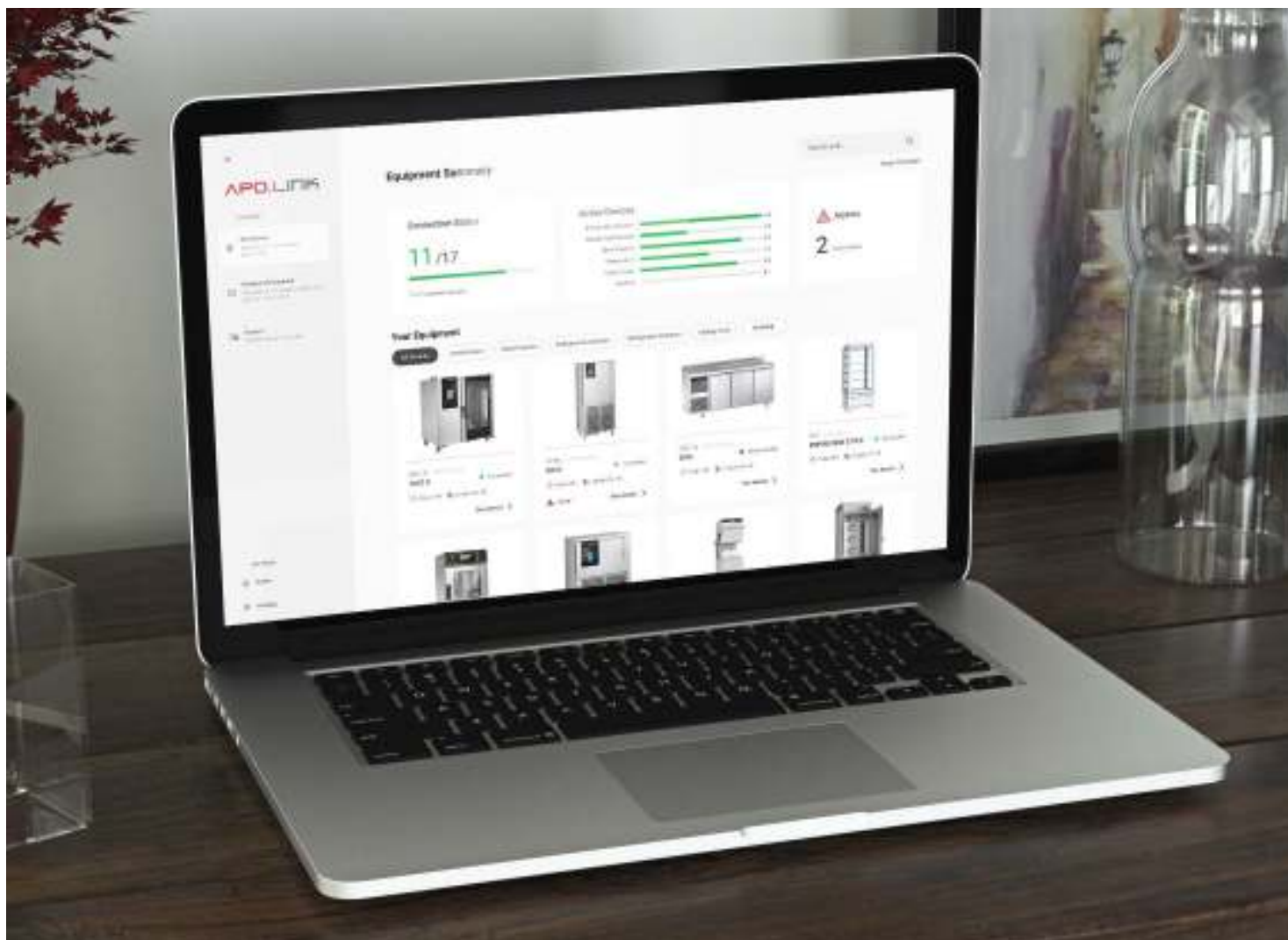

**APO.LINK , UN LOGICIEL DE GESTION DÉDIÉ ET GRATUIT
POUR OPTIMISER LES PROCESSUS EN CUISINE**



Alarmes
HACCP



Notifications par
courriel et/ou
smartphone



Toutes les
données pour
le meilleur
télédiagnostic

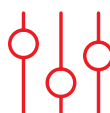

Modifier
les paramètres



Indicateurs
de processus



Consommations



Cybersécurité et
Confidentialité
garanties

Données en temps réel et historiques, affichage de l'état de la machine en temps réel, modification des paramètres, archive de l'historique, consommation (selon le produit), pour améliorer l'efficacité de la cuisine et mieux gérer les activités.

ACCESSOIRE DE CONNECTIVITÉ MONTÉ EN USINE



Fours

ACT.O AT...
ou
accessoire **KIOT** =



TAST.O AX...



PRACTICO TT...

Armoires frigorifiques
X-TRA PLUS

TX...LI

Banques réfrigérées
DIV.A

L7... / L6... / M7... / M6...

Lave-vaisselle

KE...LI

TE...

OPTION CONNECTIVITÉ

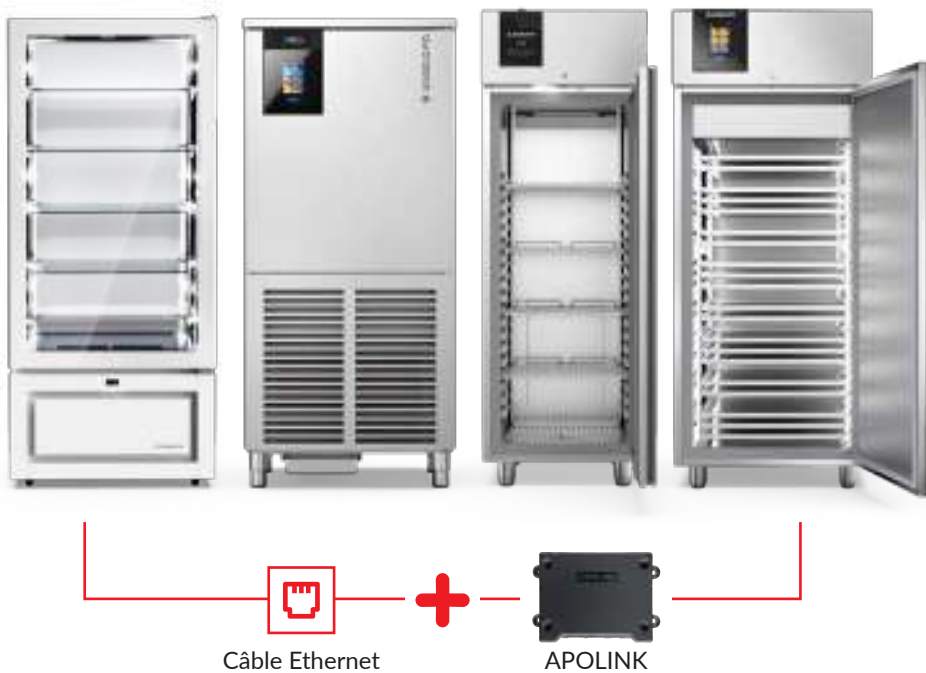

Cellules mixte de refroidissement rapide

ARI.O
IDE.O
CHILLSTAR ECO+
BLITZ Roll-In

Armoires frigorifiques

X-CEL
X-TRA PLUS (à partir de janvier 2024)
QSR

Banques réfrigérées DIV.A

P7... / P6... / PR... / N7... / N6... / NR...

Pâtisserie et Crème Glacée

Armoires de fermentation contrôlée AF...HC
Armoires frigorifiques FS...
Armoire crème glacée AGL6HC...
Surgélateur rapide HPA51M

Vitrines verticales réfrigérées

EMPIRE NEW STYLE

La gamme de produits connectables au portail est en constante évolution.

Contactez l'entreprise pour recevoir de plus amples informations sur la possibilité de bénéficier des avantages fiscaux Industrie 4.0 pour le marché italien et pour vérifier la disponibilité du portail APO.LINK pour tous les autres pays.

CHEF4YOU

Formation, efficacité, résultats,
avec un Chef à votre service.



Service Corporate Chef Après vente

TERMES ET CONDITIONS

Objet de la consultation

Angelo Po fournit un service de conseil professionnel assuré par un Chef qualifié afin de soutenir le client utilisateur et/ou le partenaire commercial dans l'utilisation optimale **des équipements installés**.

Le service vise à améliorer l'efficacité opérationnelle, la qualité du travail et la sécurité dans l'intégration des équipements aux processus de cuisson.

Prix net du service

Référence commerciale pour devis et commandes :



- **CHEFDAY* € 650 (prix net)** journée entière (max. 6 h de conseil)
- **CHEFHALF* € 400 (prix net)** demi journée (max. 3 h de conseil)
- Frais de déplacement inclus* : les frais de voyage du chef sont à la charge d'Angelo Po

* Conditions valables pour l'Italie et les pays de l'UE. Pour les pays hors UE, contacter le représentant commercial.



Délais de réalisation du service

Pour les nouvelles installations, le partenaire commercial Angelo Po **communique lors de la commande la date prévue d'installation au service gestion des commandes ou au représentant commercial**.

Pour l'Italie et les pays de l'Union Européenne : Angelo Po communiquera la première date disponible pour la réalisation du service après vérification de l'organisation interne ; le Client et/ou le partenaire commercial devra confirmer cette date.

Pour les pays hors UE : contacter le représentant commercial.

Replanification : toute modification de date demandée par le Client et/ou le partenaire commercial dans les 10 jours précédant la réalisation du service entraînera la facturation des frais déjà engagés et documentés par Angelo Po.



Langues de réalisation du service

Le service peut être fourni en italien, anglais, espagnol et français.

Le service est fourni en tant que conseil professionnel et ne peut être considéré comme garantissant des résultats spécifiques en termes de performance commerciale du Client.

MASTER 700 - 600

Performance quotidienne, qualité professionnelle

La gamme Master a été créée pour concevoir des espaces de cuisine et de laboratoire hautement professionnels, où chaque élément, des plonges aux tables, des placards muraux aux armoires chauffantes, est conçu pour faciliter la bonne utilisation des outils et une répartition optimale des fonctions.

Une conception coordonnée, parfaitement en harmonie avec le reste de la gamme Angelo Po, associés à des matériaux et des structures durables, garantit une solidité même dans les conditions d'utilisation les plus intensives.

L'acier inoxydable AISI 304 est utilisé dans chaque surface destinée à venir en

contact avec les aliments.

Le dossier arrière est fabriqué d'une seule pièce avec le dessus de travail et présente un dos caissonné pour éviter toute infiltration de saleté.

Les dessus de travail, en acier inox AISI 304 épaisseur 12/10 mm finement satiné, d'une hauteur de 54 mm: robustesse et isolation acoustique sont assurées par une structure spéciale et un sous plan en matériau absorbant acoustique.

Les cuves, insérées par soudage au dessus et nettoyage robotisé sont également réalisées en acier inoxydable AISI 304 embouties à froid, avec un

grand réservoir. Un matériau anti-bruit spécial est appliqué sur le fond extérieur de chaque cuve.

Les usinages, la haute qualité des matériaux et le soin apporté par la fabrication confèrent à chaque projet un caractère distinctif, garantissant robustesse et longue durée.

Une gamme complète : deux profondeurs - 60 et 70 cm - et de nombreuses possibilités de composition pour tables, plonges, armoires, ainsi que des solutions avec plan unique permettant d'intégrer armoires, banques réfrigérées ou blocs tiroirs, avec possibilité de plinthes.



MASTER

PREPARATION 700 - 600



Conception n coordonnée avec le reste de l'équipement Angelo Po



Hauteur des armoires : confort, ergonomie, efficacité



Deux profondeurs disponibles



Design soigné dans les moindres détails

Solutions complètes pour une cuisine modern



Regulation (EC) No 1935/2004

Nos modules de préparation sont fabriqués en acier inoxydable AISI 304 conformément à la réglementation M.O.C.A., garantissant une sécurité alimentaire maximale et aucune libération de substances nocives. Une qualité certifiée qui garantit des surfaces et des équipements totalement adaptés au contact alimentaire pour un environnement de travail sûr, propre et professionnel.

Solutions avec un plan de travail unique, sous lequel installer des armoires neutres ou chauffantes, des éléments à tiroirs, des trémies, des banques réfrigérées et, pour compléter la solution, un socle également en acier inoxydable AISI 304

Plans de travail en acier inoxydable AISI 304 satiné avec ou sans dossieret fabriqué d'une seule pièce avec le plan



Tables-armoires, neutres ou chauffantes, avec ouverture sur une façade ou deux façces, éléments avec tiroirs, trémies

Socle en acier inoxydable AISI 304 avec fixation par clips. Pour les socles latéraux sur banques réfrigérées positionnées à droite ou à gauche d'un plan de travail unique, veuillez nous contacter

AISI 304



100 mm
54 mm

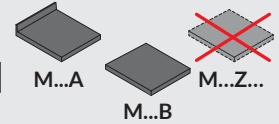

Acier inoxydable AISI 304 : résistant à la corrosion, hygiénique et durable

Flexibilité maximale et combinaisons infinies

Dessus de travail en acier inoxydable AISI 304, épaisseur 12/10 mm

Cuves soudées en acier inoxydable AISI 304, avec un matériau insonorisant sur le fond extérieur pour réduire le bruit

Égouttoirs à surface nervurée emboutis, inclinés pour diriger l'eau vers la cuve

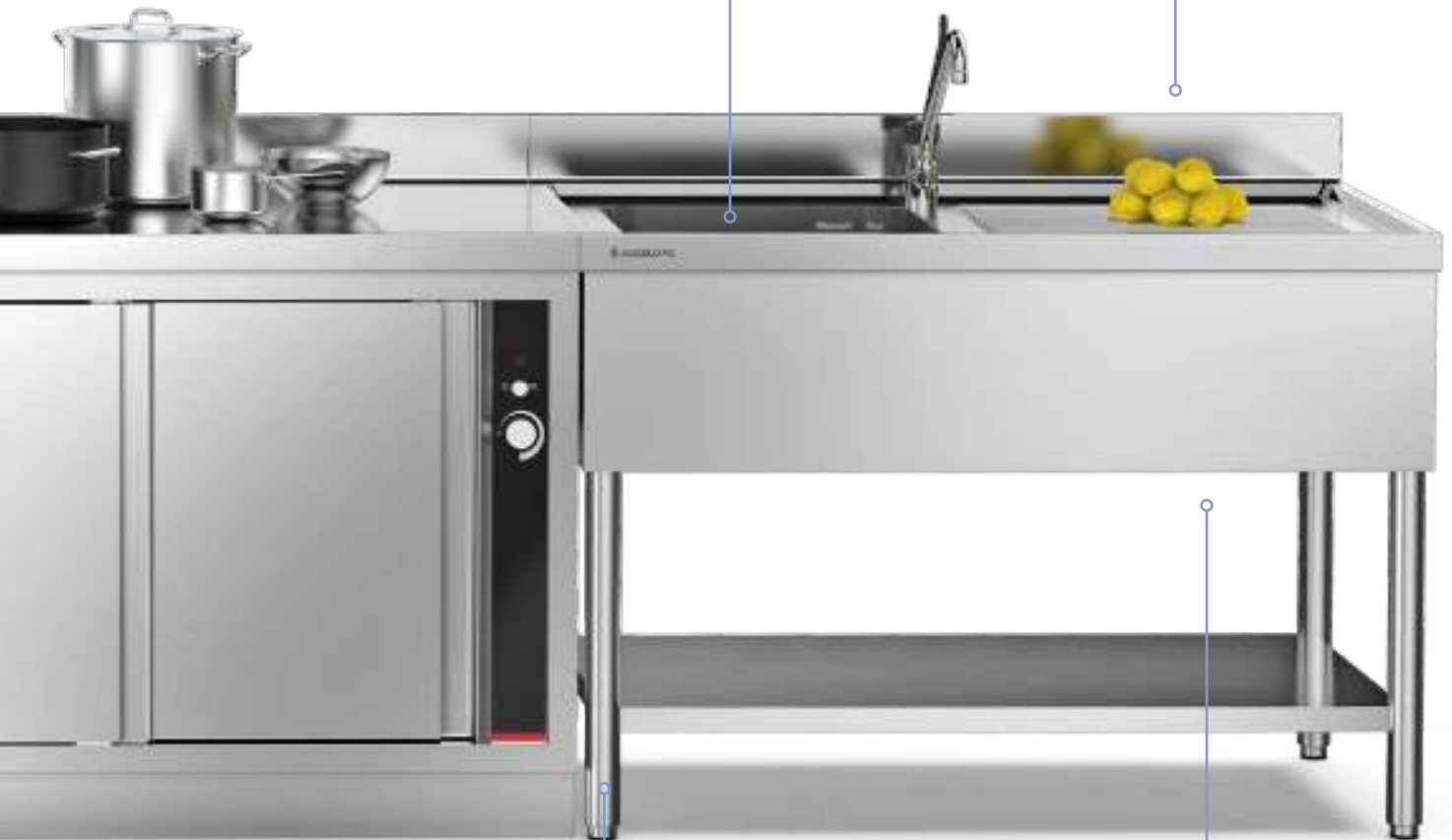

Pieds tubulaires en acier inoxydable AISI 304 finition satinée, épaisseur 50 mm, réglables +/-3 cm

Structures ouvertes avec panneaux de façade ou armoires fermées avec côtés, fond et portes en acier inoxydable AISI 304

MASTER CONFIGURATEUR PREPARATION

MASTER 700 : Tables du chef bac/trou vide ordure: tiroirs et de montage correspondant étagère inférieure

	120	140	160	180	200 cm
1		M14TAVD • M14TAVS			M20TAVD • M20TAVS
3		M14RFV			M20RFV
2	M12TAFD • M12TAFS	M14TAFD • M14TAFS	M16TAFD • M16TAFS	M18TAFD • M18TAFS	M20TAFD • M20TAFS
3	M08RF	M10RF	M12RF	M14RF	M16RF

MASTER 700 : Plonges pré-équipés pour lave-vaisselle

	120	140	160	200
1	M12L14DL • M12L14SL	M14L16DL • M14L16SL	M16L24DL • M16L24SL	M20L26DL • M20L26SL
2	M06RF	M08RF	M10RF	M14RF
3			MLA624DL • MLA624SL	MLA226DL • MLA226SL

MASTER CONFIGURATEUR PREPARATION

MASTER 700 : Plonges

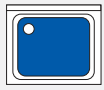
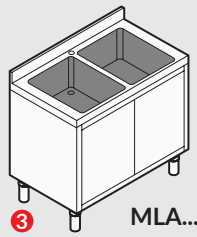
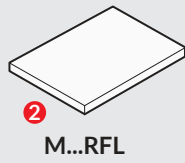
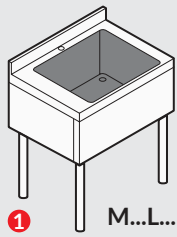

cm 40x50x25 h

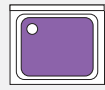

cm 50x50x30 h

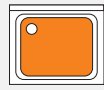

cm 60x50x30 h

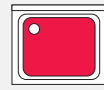

cm 80x51x30 h

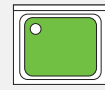

cm 128x51x35 h

* D: egouttoir droit • S: egouttoir gauche

	60	70	80	100	110	120	140	160	180	200	220	260 cm
1		M07L15	M08L16	M10L24	M11L18	M12L14D/S M12L246	M14L112 M14L24D/S M14L16D/S M14L26	M16L24D/S	M18L24 M18L26D/S	M20L26D/S M20L28	M22L26	
2		M07RFL	M08RFL	M10RFL	M11RFL	M12RFL	M14RFL	M16RFL	M18RFL	M20RFL	M22RFL	
3	MLA0614	MLA0715	MLA0816 MLA0816C	MLA1024		MLA1214D/S MLA12246	MLA1424D/S MLA1416D/S MLA1426	MLA1624D/S	MLA1824 MLA1826D/S	MLA2026D/S MLA2028	MLA2226	MLA2626

MASTER CONFIGURATEUR PREPARATION

MASTER 700: Plan unique

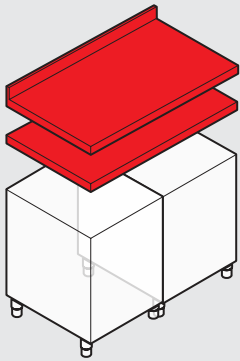

M...UA

M...UB

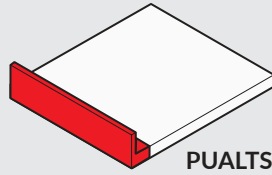

PUALTS

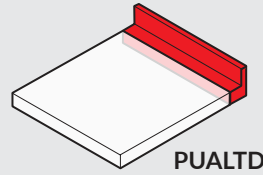

PUALTD

Cuves



cm 40x50x25 h
PUV4050



cm 50x50x25 h
PUV5050



cm 80x50x25 h
PUV8050



cm 40x50x25 h
PUVI4050



cm 50x50x25 h
PUVI5050



cm 50x50x25 h
PUINV13

Cuves avec retenue

Soubassements armoires sans dessus pour cuve

50	60	70	80	90	100 cm
MPUSL05	MPUSL06	MPUSL07	MPUSL08	MPUSL09	MPUSL10

MASTER 600: Plonges

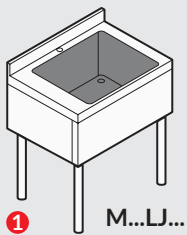

M...LJ...

+

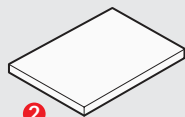

M...RFJL

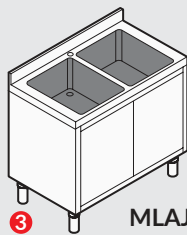

MLAJ...

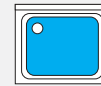

cm 40x40x25 h

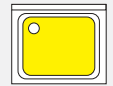

cm 50x40x25 h







* D: lave-vaisselle droite • S: lave-vaisselle gauche







	80	100	120	140	160 cm
1					
	M08LJ16	M10LJ24	M12LJ14D • M12LJ14S	M14LJ24D • M14LJ24S	M16LJ24D • M16LJ24S
2	M08RFJL	M10RFJL	M12RFJL	M14RFJL	M16RFJL
3					
		MLAJ1024	MLAJ121D • MLAJ121S	MLAJ142D • MLAJ142S	MLAJ162D • MLAJ162S







PREPARATION MASTER 700

TABLES DE TRAVAIL











Plan de travail en acier inoxydable AISI 304 satiné, épaisseur 12/10 mm, hauteur 54 mm, panneau insonorisant, hydrofuge et ignifuge, adapté à des charges maximales de 150 kg/m² garanties par l'appui au sol de pieds tubulaires en acier inoxydable Ø 50 mm. M...A: dessus de travail avec dossier arrière h 100mm. M...B: dessus sans dossier arrière.

	MOD.	DESCRIPTION					
	M06TA	TABLE AVEC PLAN DE TRAVAIL ET DOSSERET ARRIÈRE 60 CM	60x70x100				<input type="checkbox"/>
	M07TA	TABLE AVEC PLAN DE TRAVAIL ET DOSSERET ARRIÈRE 70 CM	70x70x100				<input type="checkbox"/>
	M08TA	TABLE AVEC PLAN DE TRAVAIL ET DOSSERET ARRIÈRE 80 CM	80x70x100				<input type="checkbox"/>
	M09TA	TABLE AVEC PLAN DE TRAVAIL ET DOSSERET ARRIÈRE 90 CM	90x70x100				<input type="checkbox"/>
	M10TA	TABLE AVEC PLAN DE TRAVAIL ET DOSSERET ARRIÈRE 100 CM	100x70x100				<input type="checkbox"/>
	M11TA	TABLE AVEC PLAN DE TRAVAIL ET DOSSERET ARRIÈRE 110 CM	110x70x100				<input type="checkbox"/>
	M12TA	TABLE AVEC PLAN DE TRAVAIL ET DOSSERET ARRIÈRE 120 CM	120x70x100				<input type="checkbox"/>
	M13TA	TABLE AVEC PLAN DE TRAVAIL ET DOSSERET ARRIÈRE 130 CM	130x70x100				<input type="checkbox"/>
	M14TA	TABLE AVEC PLAN DE TRAVAIL ET DOSSERET ARRIÈRE 140 CM	140x70x100				<input type="checkbox"/>
	M15TA	TABLE AVEC PLAN DE TRAVAIL ET DOSSERET ARRIÈRE 150 CM	150x70x100				<input type="checkbox"/>
	M16TA	TABLE AVEC PLAN DE TRAVAIL ET DOSSERET ARRIÈRE 160 CM	160x70x100				<input type="checkbox"/>
	M17TA	TABLE AVEC PLAN DE TRAVAIL ET DOSSERET ARRIÈRE 170 CM	170x70x100				<input type="checkbox"/>
	M18TA	TABLE AVEC PLAN DE TRAVAIL ET DOSSERET ARRIÈRE 180 CM	180x70x100				<input type="checkbox"/>
	M19TA	TABLE AVEC PLAN DE TRAVAIL ET DOSSERET ARRIÈRE 190 CM	190x70x100				<input type="checkbox"/>
M20TA	TABLE AVEC PLAN DE TRAVAIL ET DOSSERET ARRIÈRE 200 CM	200x70x100				<input type="checkbox"/>	
M21TA	TABLE AVEC PLAN DE TRAVAIL ET DOSSERET ARRIÈRE 210 CM	210x70x100				<input type="checkbox"/>	
M22TA	TABLE AVEC PLAN DE TRAVAIL ET DOSSERET ARRIÈRE 220 CM	220x70x100				<input type="checkbox"/>	
M23TA	TABLE AVEC PLAN DE TRAVAIL ET DOSSERET ARRIÈRE 230 CM	230x70x100				<input type="checkbox"/>	









MOD.	DESCRIPTION	   	€	
	M24TA	TABLE AVEC PLAN DE TRAVAIL ET DOSSERET ARRIÈRE 240 CM	240x70x100	<input type="checkbox"/>
	M25TA	TABLE AVEC PLAN DE TRAVAIL ET DOSSERET ARRIÈRE 250 CM	250x70x100	<input type="checkbox"/>
	M26TA	TABLE AVEC PLAN DE TRAVAIL ET DOSSERET ARRIÈRE 260 CM	260x70x100	<input type="checkbox"/>
	M27TA	TABLE AVEC PLAN DE TRAVAIL ET DOSSERET ARRIÈRE 270 CM	270x70x100	<input type="checkbox"/>
	M28TA	TABLE AVEC PLAN DE TRAVAIL ET DOSSERET ARRIÈRE 280 CM	280x70x100	<input type="checkbox"/>
	M29TA	TABLE AVEC PLAN DE TRAVAIL ET DOSSERET ARRIÈRE 290 CM	290x70x100	<input type="checkbox"/>
	M30TA	TABLE AVEC PLAN DE TRAVAIL ET DOSSERET ARRIÈRE 300 CM	300x70x100	<input type="checkbox"/>
	M06TB	TABLE AVEC PLAN DE TRAVAIL 60 CM	60x70x90	<input type="checkbox"/>
	M07TB	TABLE AVEC PLAN DE TRAVAIL 70 CM	70x70x90	<input type="checkbox"/>
	M08TB	TABLE AVEC PLAN DE TRAVAIL 80 CM	80x70x90	<input type="checkbox"/>
	M09TB	TABLE AVEC PLAN DE TRAVAIL 90 CM	90x70x90	<input type="checkbox"/>
	M10TB	TABLE AVEC PLAN DE TRAVAIL 100 CM	100x70x90	<input type="checkbox"/>
	M11TB	TABLE AVEC PLAN DE TRAVAIL 110 CM	110x70x90	<input type="checkbox"/>
	M12TB	TABLE AVEC PLAN DE TRAVAIL 120 CM	120x70x90	<input type="checkbox"/>
	M13TB	TABLE AVEC PLAN DE TRAVAIL 130 CM	130x70x90	<input type="checkbox"/>
	M14TB	TABLE AVEC PLAN DE TRAVAIL 140 CM	70x140x90	<input type="checkbox"/>
	M15TB	TABLE AVEC PLAN DE TRAVAIL 150 CM	150x70x90	<input type="checkbox"/>
	M16TB	TABLE AVEC PLAN DE TRAVAIL 160 CM	160x70x90	<input type="checkbox"/>
	M17TB	TABLE AVEC PLAN DE TRAVAIL 170 CM	170x70x90	<input type="checkbox"/>
	M18TB	TABLE AVEC PLAN DE TRAVAIL 180 CM	180x70x90	<input type="checkbox"/>
	M19TB	TABLE AVEC PLAN DE TRAVAIL 190 CM	190x70x90	<input type="checkbox"/>
	M20TB	TABLE AVEC PLAN DE TRAVAIL 200 CM	200x70x90	<input type="checkbox"/>
M21TB	TABLE AVEC PLAN DE TRAVAIL 210 CM	210x70x90	<input type="checkbox"/>	

	MOD.	DESCRIPTION					€
	M22TB	TABLE AVEC PLAN DE TRAVAIL 220 CM	220x70x90				<input type="checkbox"/>
	M23TB	TABLE AVEC PLAN DE TRAVAIL 230 CM	230x70x90				<input type="checkbox"/>
	M24TB	TABLE AVEC PLAN DE TRAVAIL 240 CM	240x70x90				<input type="checkbox"/>
	M25TB	TABLE AVEC PLAN DE TRAVAIL 250 CM	250x70x90				<input type="checkbox"/>
	M26TB	TABLE AVEC PLAN DE TRAVAIL 260 CM	260x70x90				<input type="checkbox"/>
	M27TB	TABLE AVEC PLAN DE TRAVAIL 270 CM	270x70x90				<input type="checkbox"/>
	M28TB	TABLE AVEC PLAN DE TRAVAIL 280 CM	280x70x90				<input type="checkbox"/>
	M29TB	TABLE AVEC PLAN DE TRAVAIL 290 CM	290x70x90				<input type="checkbox"/>
	M30TB	TABLE AVEC PLAN DE TRAVAIL 300 CM	300x70x90				<input type="checkbox"/>

ACCESSOIRES

	MOD.	DESCRIPTION					€
	MCAA	TABLE DE TRAVAIL SUSPENDUE EN ANGLE	98,6x98,6x14,5				<input type="checkbox"/>
	MGPAA	PIED POUR TABLE DE TRAVAIL SUSPENDUE EN ANGLE	20x80x14				<input type="checkbox"/>
	M04C111	TIROIR EMPILABLE EN ACIER INOX GN 1/1	40x70x21				<input type="checkbox"/>
	M04C123	TIROIR EN ACIER INOX 13 LITRES	38x58,5x12,1				<input type="checkbox"/>
	M04C411	4 TIROIRS EN ACIER INOXYDABLE GN 1/1	40x70x62				<input type="checkbox"/>
	M06RF	ÉTAGERE INFÉRIEURE POUR TABLE DE TRAVAIL DE 60 CM	48,4x57,4x3,7				<input type="checkbox"/>
	M07RF	ÉTAGERE INFÉRIEURE POUR TABLE DE TRAVAIL DE 70 CM	58,4x57,4x3,7				<input type="checkbox"/>
	M08RF	ÉTAGERE INFÉRIEURE POUR TABLE DE TRAVAIL DE 80 CM	68,4x57,4x3,7				<input type="checkbox"/>
	M09RF	ÉTAGERE INFÉRIEURE POUR TABLE DE TRAVAIL DE 90 CM	78,4x57,4x3,7				<input type="checkbox"/>
	M10RF	ÉTAGERE INFÉRIEURE POUR TABLE DE TRAVAIL DE 100 CM	88,4x57x3,7				<input type="checkbox"/>

ACCESSOIRES







	MOD.	DESCRIPTION					
	M11RF	ÉTAGÈRE INFÉRIEURE POUR TABLE DE TRAVAIL DE 100 CM	98,4x57,4x3,7				<input type="checkbox"/>
	M12RF	ÉTAGÈRE INFÉRIEURE POUR TABLE DE TRAVAIL DE 120 CM	108,4x57,4x3,7				<input type="checkbox"/>
	M13RF	ÉTAGÈRE INFÉRIEURE POUR TABLE DE TRAVAIL DE 130 CM	118,4x57,4x3,7				<input type="checkbox"/>
	M14RF	ÉTAGÈRE INFÉRIEURE POUR TABLE DE TRAVAIL DE 140 CM	128,4x57,4x3,7				<input type="checkbox"/>
	M15RF	ÉTAGÈRE INFÉRIEURE POUR TABLE DE TRAVAIL DE 150 CM	138,4x57,4x3,7				<input type="checkbox"/>
	M16RF	ÉTAGÈRE INFÉRIEURE POUR TABLE DE TRAVAIL DE 160 CM	148,4x57,4x3,7				<input type="checkbox"/>
	M17RF	ÉTAGÈRE INFÉRIEURE POUR TABLE DE TRAVAIL DE 170 CM	158,4x57,4x3,7				<input type="checkbox"/>
	M18RF	ÉTAGÈRE INFÉRIEURE POUR TABLE DE TRAVAIL DE 180 CM	168,4x57,4x3,7				<input type="checkbox"/>
	M19RF	ÉTAGÈRE INFÉRIEURE POUR TABLE DE TRAVAIL DE 190 CM	178,4x57,4x3,7				<input type="checkbox"/>
	M20RF	ÉTAGÈRE INFÉRIEURE POUR TABLE DE TRAVAIL DE 200 CM	188,4x57,4x3,7				<input type="checkbox"/>
	M21RF	ÉTAGÈRE INFÉRIEURE POUR TABLE DE TRAVAIL DE 210 CM	198,4x57,4x3,7				<input type="checkbox"/>
	M22RF	ÉTAGÈRE INFÉRIEURE POUR TABLE DE TRAVAIL DE 220 CM	208,4x57,4x3,7				<input type="checkbox"/>
	M23RF	ÉTAGÈRE INFÉRIEURE POUR TABLE DE TRAVAIL DE 230 CM	218,4x57,4x3,7				<input type="checkbox"/>
	M24RF	ÉTAGÈRE INFÉRIEURE POUR TABLE DE TRAVAIL DE 240 CM	228,4x57,4x3,7				<input type="checkbox"/>
	M25RF	ÉTAGÈRE INFÉRIEURE POUR TABLE DE TRAVAIL DE 250 CM	238,4x57,4x3,7				<input type="checkbox"/>
	M26RF	ÉTAGÈRE INFÉRIEURE POUR TABLE DE TRAVAIL DE 260 CM	248,4x57,4x3,7				<input type="checkbox"/>
	M27RF	ÉTAGÈRE INFÉRIEURE POUR TABLE DE TRAVAIL DE 270 CM	258,4x57,4x3,7				<input type="checkbox"/>
	M28RF	ÉTAGÈRE INFÉRIEURE POUR TABLE DE TRAVAIL DE 280 CM	258,4x57,4x3,7				<input type="checkbox"/>
	M29RF	ÉTAGÈRE INFÉRIEURE POUR TABLE DE TRAVAIL DE 290 CM	278,4x57,4x5				<input type="checkbox"/>
	M30RF	ÉTAGÈRE INFÉRIEURE POUR TABLE DE TRAVAIL DE 300 CM	288,4x57,4x3,7				<input type="checkbox"/>
	KRP4GG	KIT 4 ROULETTES, 2 AVEC FREINS ET PIEDS DE TABLE	20x20x80				<input type="checkbox"/>
	KRP6GG	KIT 6 ROULETTES, 2 AVEC FREINS ET PIEDS DE TABLE	20x20x80				<input type="checkbox"/>

PREPARATION MASTER 700









TABLES DU CHEF AVEC BAC

Plan de travail en acier inoxydable AISI 304 satiné, épaisseur 12/10 mm, hauteur 54 mm, panneau insonorisant, hydrofuge et ignifuge, adapté à des charges maximales de 150 kg/m² garanties par l'appui au sol de pieds tubulaires en acier inoxydable Ø 50 mm. Cuve en acier inoxydable AISI 304 embouti à froid, dimensions 40 x 50 x 25 cm (h). M...D: bac

à droite M...S: bac à gauche.

	MOD.	DESCRIPTION					€
	M14TAVD	TABLE AVEC DOSSERET ARRIÈRE CUVE DROITE 140 CM	140x70x100				<input type="checkbox"/>
	M20TAVD	TABLE AVEC DOSSERET ARRIÈRE CUVE DROITE 200 CM	200x70x100				<input type="checkbox"/>
	M14TAVS	TABLE AVEC DOSSERET ARRIÈRE CUVE GAUCHE 140 CM	140x70x100				<input type="checkbox"/>
	M20TAVS	TABLE AVEC DOSSERET ARRIÈRE CUVE GAUCHE 200 CM	200x70x100				<input type="checkbox"/>







ACCESSOIRES

	MOD.	DESCRIPTION					€
	M14RFV	ÉTAGÈRE INFÉRIEURE POUR TABLE AVEC CUVE 140 CM	124,2x58,2x5				<input type="checkbox"/>
	M20RFV	ÉTAGÈRE INFÉRIEURE POUR TABLE AVEC CUVE 200 CM	184,2x58,2x5				<input type="checkbox"/>
	CEM	ROBINET MELANGEUR EAU CHAUDE/FROIDE	40x20x8				<input type="checkbox"/>
	CEGTV	ROBINET MELANGEUR COUDÉ EAU CHAUDE/FROIDE ROBINET	40x20x8				<input type="checkbox"/>
	EAP	GROUP MELANGEUR EAU, A COMMANDE A PEDALE À FIXER SUR L'ETAGERE BASSE	70x20x20				<input type="checkbox"/>
	MKSV25P	KIT SIPHON+ BONDE POUR BACS H 25 CM	20x30x10				<input type="checkbox"/>







PREPARATION MASTER 700

TABLE DU CHEF AVEC TROU







Plan de travail en acier inoxydable AISI 304 satiné, épaisseur 12/10 mm, hauteur 54 mm, panneau insonorisant, hydrofuge et ignifuge, adapté à des charges maximales de 150 kg/m² garanties par l'appui au sol de pieds tubulaires en acier inoxydable Ø 50 mm. Trou vide ordures Ø 24 cm soudé en continu au dessus. M...D : trou à droite. M...S : trou à gauche.

	MOD.	DESCRIPTION					€
	M12TAFD	TABLE AVEC DOSSERET ARRIÈRE TROU DROIT 120 CM	120x70x100				<input type="checkbox"/>
	M14TAFD	TABLE AVEC DOSSERET ARRIÈRE TROU DROIT 140 CM	140x70x100				<input type="checkbox"/>
	M16TAFD	TABLE AVEC DOSSERET ARRIÈRE TROU DROIT 160 CM	160x70x100				<input type="checkbox"/>
	M18TAFD	TABLE AVEC DOSSERET ARRIÈRE TROU DROIT 180 CM	180x70x100				<input type="checkbox"/>
	M20TAFD	TABLE AVEC DOSSERET ARRIÈRE TROU DROIT 200 CM	200x70x100				<input type="checkbox"/>
	M12TAFS	TABLE AVEC DOSSERET ARRIÈRE TROU GAUCHE 120 CM	120x70x100				<input type="checkbox"/>
	M14TAFS	TABLE AVEC DOSSERET ARRIÈRE TROU GAUCHE 140 CM	140x70x100				<input type="checkbox"/>
	M16TAFS	TABLE AVEC DOSSERET ARRIÈRE TROU GAUCHE 160 CM	160x70x100				<input type="checkbox"/>
	M18TAFS	TABLE AVEC DOSSERET ARRIÈRE TROU GAUCHE 180 CM	180x70x100				<input type="checkbox"/>
	M20TAFS	TABLE AVEC DOSSERET ARRIÈRE TROU GAUCHE 200 CM	200x70x100				<input type="checkbox"/>

ACCESSOIRES

	MOD.	DESCRIPTION					€
	M08RF	ÉTAGÈRE INFÉRIEURE POUR TABLE DE TRAVAIL DE 80 CM	68,84x57,4x3,7				<input type="checkbox"/>
	M10RF	ÉTAGÈRE INFÉRIEURE POUR TABLE DE TRAVAIL DE 100 CM	88,4x57x3,7				<input type="checkbox"/>
	M12RF	ÉTAGÈRE INFÉRIEURE POUR TABLE DE TRAVAIL DE 120 CM	108,4x57,4x3,7				<input type="checkbox"/>
	M14RF	ÉTAGÈRE INFÉRIEURE POUR TABLE DE TRAVAIL DE 140 CM	128,4x57,4x3,7				<input type="checkbox"/>
	M16RF	ÉTAGÈRE INFÉRIEURE POUR TABLE DE TRAVAIL DE 160 CM	148,4x57,4x3,7				<input type="checkbox"/>
	KRP4GG	KIT 4 ROULETTES, 2 AVEC FREINS ET PIEDS DE TABLE	20x20x80				<input type="checkbox"/>

ACCESSOIRES

	MOD.	DESCRIPTION					
	PCR40	POUBELLE MOBILE OUVERTURE COUVERCLE, 50 LT	40x40x60,5				<input type="checkbox"/>
	PCR70	POUBELLE MOBILE OUVERTURE COUVERCLE, 75 LT	45x45x60,5				<input type="checkbox"/>

PREPARATION MASTER 700









TABLES DE PREPARATION

Réalisés en acier inoxydable AISI304 satiné, plan de travail h 54 mm avec dossier h 100 mm, planche à découper amovible en polyéthylène, trou d'évacuation des déchets. Modèles M6TCN...: cuve avec siphon, bonde et trop plein. Cuve M6TCN: 107x31x18,5 cm. Cuve M6TCN180: 163x31x18,5 cm. Modèles 6TPC... : plans de travail

perforés amovibles, utiles pour supporter les aliments transformés.

	MOD.	DESCRIPTION					€
	M6TCN	TABLE DE TRIAGE LEGUME INOX	120x70x100				
	M6TCN180	TABLE DE TRIAGE LEGUME INOX	180x70x100				
	M6TPC120	TABLE DE PREPARATION VIANDE-POSSOIN	120x70x100				
	M6TPC180	TABLE DE PREPARATION VIANDE-POSSOIN	180x70x100				























ACCESSOIRES











	MOD.	DESCRIPTION					€
	CEM	ROBINET MELANGEUR EAU CHAUDE/FROIDE	40x20x8				
	CEG	ROBINET MELANGEUR COUDÉ EAU CHAUDE/FROIDE ROBINET	40x20x8				







PREPARATION MASTER 700

PLONGES SUR PIEDS









Dessus avec dossieret arrière embouti en acier inoxydable AISI 304 satiné. Cuve emboutie, insérée dans le dessus par soudure continue étanche. Pieds réglables. Plonge sur pieds avec habillage de façade inox AISI 304, pieds tubulaires Ø 50 mm en inox AISI 304. Espacement 180 mm entre sol et étagère.

	MOD.	DESCRIPTION					€
	M07L15	PLONGE SUR PIEDS 1 BAC CM 50X50X30H	70x70x100				
	M08L16	PLONGE SUR PIEDS 1 BAC CM 60X50X30H	80x70x100				
	M10L24	PLONGE SUR PIEDS 2 BACS CM 40X40X25H	100x70x100				
	M11L18	PLONGE SUR PIEDS 1 BAC CM 80X51X30H	110x70x100				
	M12L14D	PLONGE SUR PIEDS 1 BAC CM 40X50X25H EGOUTTOIR DROIT	120x70x100				
	M12L14S	PLONGE SUR PIEDS 1 BAC CM 40X50X25H EGOUTTOIR DROIT	120x70x100				
	M12L246	PLONGE SUR PIEDS 2 BACS CM 40X50X25H CM 60X50X32,5H	120x70x100				
	M14L112	PLONGE SUR PIEDS 1 BAC CM 128X51X35H	140x70x100				
	M14L16D	PLONGE SUR PIEDS 1 BAC CM 60X50X32,5H EGOUTTOIR DROIT	140x70x100				

MOD.	DESCRIPTION				€
	M14L16S PLONGE SUR PIEDS 1 BAC CM 60X50X32,5H EGOUTTOIR GAUCHE	140x70x100			
	M14L24D PLONGE SUR PIEDS 2 BACS CM 40X50X25H EGOUTTOIR DROIT	140x70x100			
	M14L24S PLONGE SUR PIEDS 2 BACS CM 40X50X25H EGOUTTOIR DROIT	140x70x100			
	M14L26 PLONGE SUR PIEDS 2 BACS CM 60X50X30H	140x70x100			
	M16L24D PLONGE SUR PIEDS 2 BACS CM 40X50X25H EGOUTTOIR DROIT	160x70x100			
	M16L24S PLONGE SUR PIEDS 2 BACS CM 40X50X25H EGOUTTOIR GAUCHE	160x70x100			
	M18L24 PLONGE SUR PIEDS 2 BACS CM 40X50X25H 2 EGOUTTOIRS	180x70x100			
	M18L26D PLONGE SUR PIEDS 2 BACS CM 60X50X30H EGOUTTOIR DROIT	180x70x100			
	M18L26S PLONGE SUR PIEDS 2 BACS CM 60X50X30H EGOUTTOIR DROIT	180x70x100			
	M20L26D PLONGE SUR PIEDS 2 BACS CM 60X50X30H EGOUTTOIR DROIT	200x70x100			
	M20L26S PLONGE SUR PIEDS 2 BACS CM 60X50X30H EGOUTTOIR GAUCHE	200x70x100			

	MOD.	DESCRIPTION					€
	M20L28	PLONGE SUR PIEDS 2 BACS CM 80X51X30H	200x70x100				
	M22L26	PLONGE SUR PIEDS 2 BACS CM 60X50X30H 2 EGOUTTOIRS	220x70x100				

ACCESSOIRES















	MOD.	DESCRIPTION					€
	M07RFL	ÉTAGERE INFÉRIEURE POUR PLONGE DE 70 CM	67,1x54,2x4				
	M08RFL	ÉTAGERE INFÉRIEURE POUR PLONGE DE 80 CM	77,1x54,2x4				
	M10RFL	ÉTAGERE INFÉRIEURE POUR PLONGE DE 100 CM	97,1x54,2x4				
	M11RFL	ÉTAGERE INFÉRIEURE POUR PLONGE DE 110 CM	107,1x54,2x4				
	M12RFL	ÉTAGERE INFÉRIEURE POUR PLONGE DE 120 CM	117,1x54,2x4				
	M14RFL	ÉTAGERE INFÉRIEURE POUR PLONGE DE 140 CM	137,1x54,2x4				
	M16RFL	ÉTAGERE INFÉRIEURE POUR PLONGE DE 160 CM	157,1x54,2x4				
	M18RFL	ÉTAGERE INFÉRIEURE POUR PLONGE DE 180 CM	177,1x54,2x4				
	M20RFL	ÉTAGERE INFÉRIEURE POUR PLONGE DE 200 CM	197,1x54,2x4				
	M22RFL	ÉTAGERE INFÉRIEURE POUR PLONGE DE 220 CM	217,1x54,2x4				
	CEM	ROBINET MELANGEUR EAU CHAUDE/FROIDE	40x20x8				
	CEG	ROBINET MELANGEUR COUDÉ EAU CHAUDE/FROIDE ROBINET	40x20x8				
	EAP	GROUP MELANGEUR EAU, A COMMANDE A PEDALE À FIXER SUR L'ETAGERE BASSE	70x20x20				
	MKSV25P	KIT SIPHON+ BONDE POUR BACS H 25 CM	20x30x10				
	MKSV35P	KIT SIPHON+ BONDE POUR BACS H 30-35 CM	40x40x15				











PREPARATION MASTER 700







PLONGES SUR PLACARD

Dessus avec dossier arrière embouti en acier inoxydable AISI 304 satiné. Cuve emboutie, insérée dans le dessus par soudure continue étanche. Pieds réglables. Armoire en acier inoxydable AISI 304 avec portes coulissantes à double paroi et étagère inférieure ; fond en tôle d'acier inoxydable AISI 304 finition satinée avec renfort oméga. Unité





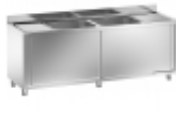



sans habillage arrière. Espacement 180 mm entre sol et étagère. Plonges de 60, 70, 80 cm avec portes battantes. Modèle MLA0816C avec tiroir sur le côté droit et porte battante sur le côté gauche.

	MOD.	DESCRIPTION					
	MLA0614	PLONGE SUR PLACARD 1 BAC CM 40X50X25H	60x70x100				
	MLA0715	PLONGE SUR PLACARD 1 BAC CM 50X50X30H	70x70x100				
	MLA0816	BAC DU CHEF SUR PLACARD 1 BAC CM 60X50X30H	80x70x100				
	MLA0816C	PLONGE SUR PLACARD 1 BAC CM 60X50X30H AVEC TIROIR	80x70x100				
	MLA1024	PLONGE SUR PLACARD 2 BACS CM 40X50X25H	100x70x100				
	MLA1214D	PLONGE SUR PLACARD 1 BAC CM 40X50X25H EGOUTTOIR DROIT	120x70x100				
	MLA1214S	PLONGE SUR PLACARD 1 BAC CM 40X50X25H EGOUTTOIR GAUCHE	120x70x100				
	MLA12246	PLONGE SUR PLACARD 2 BACS CM 40X50X25H CM 60X50X32,5H	120x70x100				
	MLA1424D	PLONGE SUR PLACARD 2 BACS CM 40X50X25H EGOUTTOIR DROIT	140x70x100				

MOD.	DESCRIPTION				€
	MLA1424S PLONGE SUR PLACARD 2 BACS CM 40X50X25H EGOUTTOIR GAUCHE	140x70x100			
	MLA1416D PLONGE SUR PLACARD 1 BAC CM 60X50X30H EGOUTTOIR DROIT	140x70x100			
	MLA1416S PLONGE SUR PLACARD 1 BAC CM 60X50X30H EGOUTTOIR GAUCHE	140x70x100			
	MLA1426 PLONGE SUR PLACARD 2 BACS CM 60X50X30H	140x70x100			
	MLA1624D PLONGE SUR PLACARD 2 BACS CM 40X50X25H EGOUTTOIR DROIT	160x70x100			
	MLA1624S PLONGE SUR PLACARD 2 BACS CM 40X50X25H EGOUTTOIR GAUCHE	160x70x100			
	MLA1826D PLONGE SUR PLACARD 2 BACS CM 60X50X30H EGOUTTOIR DROIT	180x70x100			
	MLA1826S PLONGE SUR PLACARD 2 BACS CM 60X50X30H EGOUTTOIR GAUCHE	180x70x100			
	MLA1824 PLONGE SUR PLACARD 2 BACS CM 40X50X25H 2 EGOUTTOIRS	180x70x100			
	MLA2026D PLONGE SUR PLACARD 2 BACS CM 60X50X30H EGOUTTOIR DROIT	200x70x100			
	MLA2026S PLONGE SUR PLACARD 2 BACS CM 60X50X30H EGOUTTOIR GAUCHE	200x70x100			

	MOD.	DESCRIPTION					€
	MLA2028	PLONGE SUR PLACARD 2 BACS CM 80X51X30H	200x70x100				<input type="checkbox"/>
	MLA2226	PLONGE SUR PLACARD 2 BACS CM 60X50X32,5H 2 EGOUTTOIRS	220x70x100				<input type="checkbox"/>
	MLA2626	PLONGE SUR PLACARD 2 BACS CM 60X50X32,5H 2 EGOUTTOIRS	260x70x100				<input type="checkbox"/>























ACCESSOIRES







	MOD.	DESCRIPTION					€
	CEM	ROBINET MELANGEUR EAU CHAUDE/FROIDE	40x20x8				<input type="checkbox"/>
	CEG	ROBINET MELANGEUR COUDÉ EAU CHAUDE/FROIDE ROBINET	40x20x8				<input type="checkbox"/>
	EAP	GROUP MELANGEUR EAU, A COMMANDE A PEDALE À FIXER SUR L'ETAGERE BASSE	70x20x20				<input type="checkbox"/>
	MKSV25P	KIT SIPHON+ BONDE POUR BACS H 25 CM	20x30x10				<input type="checkbox"/>
	MKSV35P	KIT SIPHON+ BONDE POUR BACS H 30-35 CM	40x40x15				<input type="checkbox"/>

PREPARATION MASTER 700









PLONGES PRE-ÉQUIPÉS POUR LAVE-VASEILLE

Dessus avec dossieret arrière embouti en acier inoxydable AISI 304 satiné. Cuve emboutie, insérée dans le dessus par soudure continue étanche. Pieds réglables. Plonge sur pieds avec habillage de façade inox AISI 304, pieds tubulaires Ø 50 mm en inox AISI 304. Espacement 180 mm entre sol et étagère.

MOD.	DESCRIPTION					€
	M12L14DL PLONGE SUR PIEDS 1 BAC CM 40X50X25H EGOUTTOIR DROIT	120x70x100				
	M12L14SL PLONGE SUR PIEDS 1 BAC CM 40X50X25H EGOUTTOIR GAUCHE	120x70x100				
	M14L16DL PLONGE SUR PIEDS 1 BAC CM 60X50X32,5H EGOUTTOIR DROIT	140x70x100				
	M14L16SL PLONGE SUR PIEDS 1 BAC CM 60X50X32,5H EGOUTTOIR GAUCHE	140x70x100				
	M16L24DL PLONGE SUR PIEDS 2 BACS CM 40X50X25H EGOUTTOIR DROIT	160x70x100				
	M16L24SL PLONGE SUR PIEDS 2 BACS CM 40X50X25H EGOUTTOIR GAUCHE	160x70x100				
	M20L26DL PLONGE SUR PIEDS 2 BACS CM 60X50X30H EGOUTTOIR DROIT	200x70x100				
	M20L26SL PLONGE SUR PIEDS 2 BACS CM 60X50X30H EGOUTTOIR GAUCHE	200x70x100				
	MLA624DL PLONGE SUR PLACARD 2 BACS CM 40X50X25H EGOUTTOIR DROIT	160x70x100				

	MOD.	DESCRIPTION					€
	MLA624SL	PLONGE SUR PLACARD 2 BACS CM 40X50X25H EGOOUTTOIR GAUCHE	160x70x100				
	MLA226DL	PLONGE SUR PLACARD 2 BACS CM 60X50X30H EGOOUTTOIR DROIT	200x70x100				
	MLA226SL	PLONGE SUR PLACARD 2 BACS CM 60X50X30H EGOOUTTOIR GAUCHE	200x70x100				

ACCESSOIRES







	MOD.	DESCRIPTION					€
	CEM	ROBINET MELANGEUR EAU CHAUDE/FROIDE	40x20x8				
	CEG	ROBINET MELANGEUR COUDÉ EAU CHAUDE/FROIDE ROBINET	40x20x8				
	EAP	GROUP MELANGEUR EAU, A COMMANDE A PEDALE À FIXER SUR L'ETAGERE BASSE	70x20x20				
	MKSV25P	KIT SIPHON+ BONDE POUR BACS H 25 CM	20x30x10				
	MKSV35P	KIT SIPHON+ BONDE POUR BACS H 30-35 CM	40x40x15				
	M06RFL	ÉTAGERE INFÉRIEURE POUR PLONGE DE 60 CM	57,1x54,2x4				
	M08RFL	ÉTAGERE INFÉRIEURE POUR PLONGE DE 80 CM	77,1x54,2x4				
	M10RFL	ÉTAGERE INFÉRIEURE POUR PLONGE DE 100 CM	97,1x54,2x4				
	M14RFL	ÉTAGERE INFÉRIEURE POUR PLONGE DE 140 CM	137,1x54,2x4				







PREPARATION MASTER 700









TABLES-ARMOIRES AVEC PORTES COULISSANTES

Structure autoportante en acier inoxydable AISI 304 finition satinée, portes coulissantes à double paroi, étagère intermédiaire renforcée en oméga, pieds réglables en acier inoxydable. Plan de travail en acier inoxydable AISI 304 finition satinée, hauteur 54 mm, épaisseur 12/10. ...B : Plan de travail sans dossier arrière. ...A :

Plan de travail avec dossier arrière h 100mm. ...1: ouverture sur une face. ...2: ouverture sur deux faces. ...E : chauffage ventilé avec thermostat +30/+90°C.



	MOD.	DESCRIPTION					
	MA10A1	TABLE ARMOIRE AVEC DOSSERET ARRIÈRE PORTES COULISSANTES	100x70x100				<input type="checkbox"/>
	MA11A1	TABLE ARMOIRE AVEC DOSSERET ARRIÈRE PORTES COULISSANTES	110x70x100				<input type="checkbox"/>
	MA12A1	TABLE ARMOIRE AVEC DOSSERET ARRIÈRE PORTES COULISSANTES	120x70x100				<input type="checkbox"/>
	MA13A1	TABLE ARMOIRE AVEC DOSSERET ARRIÈRE PORTES COULISSANTES	130x70x100				<input type="checkbox"/>
	MA14A1	TABLE ARMOIRE AVEC DOSSERET ARRIÈRE PORTES COULISSANTES	140x70x100				<input type="checkbox"/>
	MA15A1	TABLE ARMOIRE AVEC DOSSERET ARRIÈRE PORTES COULISSANTES	150x70x100				<input type="checkbox"/>
	MA16A1	TABLE ARMOIRE AVEC DOSSERET ARRIÈRE PORTES COULISSANTES	160x70x100				<input type="checkbox"/>
	MA17A1	TABLE ARMOIRE AVEC DOSSERET ARRIÈRE PORTES COULISSANTES	170x70x100				<input type="checkbox"/>
	MA18A1	TABLE ARMOIRE AVEC DOSSERET ARRIÈRE PORTES COULISSANTES	180x70x100				<input type="checkbox"/>
	MA19A1	TABLE ARMOIRE AVEC DOSSERET ARRIÈRE PORTES COULISSANTES	190x70x100				<input type="checkbox"/>
	MA20A1	TABLE ARMOIRE AVEC DOSSERET ARRIÈRE PORTES COULISSANTES	200x70x100				<input type="checkbox"/>
	MA21A1	TABLE ARMOIRE AVEC DOSSERET ARRIÈRE PORTES COULISSANTES	210x70x100				<input type="checkbox"/>
MA22A1	TABLE ARMOIRE AVEC DOSSERET ARRIÈRE PORTES COULISSANTES	220x70x100				<input type="checkbox"/>	
	MA10B1	TABLE ARMOIRE AVEC PORTES COULISSANTES	100x70x90				<input type="checkbox"/>
	MA11B1	TABLE ARMOIRE AVEC PORTES COULISSANTES	110x70x90				<input type="checkbox"/>
	MA12B1	TABLE ARMOIRE AVEC PORTES COULISSANTES	120x70x90				<input type="checkbox"/>
	MA13B1	TABLE ARMOIRE AVEC PORTES COULISSANTES	130x70x90				<input type="checkbox"/>
	MA14B1	TABLE ARMOIRE AVEC PORTES COULISSANTES	140x70x90				<input type="checkbox"/>
	MA15B1	TABLE ARMOIRE AVEC PORTES COULISSANTES	150x70x90				<input type="checkbox"/>

	MOD.	DESCRIPTION					€
	MA16B1	TABLE ARMOIRE AVEC PORTES COULISSANTES	160x70x90				<input type="checkbox"/>
	MA17B1	TABLE ARMOIRE AVEC PORTES COULISSANTES	170x70x90				<input type="checkbox"/>
	MA18B1	TABLE ARMOIRE AVEC PORTES COULISSANTES	180x70x90				<input type="checkbox"/>
	MA19B1	TABLE ARMOIRE AVEC PORTES COULISSANTES	190x70x90				<input type="checkbox"/>
	MA20B1	TABLE ARMOIRE AVEC PORTES COULISSANTES	200x70x90				<input type="checkbox"/>
	MA21B1	TABLE ARMOIRE AVEC PORTES COULISSANTES	210x70x90				<input type="checkbox"/>
	MA22B1	TABLE ARMOIRE AVEC PORTES COULISSANTES	220x70x90				<input type="checkbox"/>
	MA10B2	TABLE ARMOIRE PORTES COULISSANTES 2 COTÉS	100x70x90				<input type="checkbox"/>
	MA11B2	TABLE ARMOIRE PORTES COULISSANTES 2 COTÉS	110x70x90				<input type="checkbox"/>
	MA12B2	TABLE ARMOIRE PORTES COULISSANTES 2 COTÉS	120x70x90				<input type="checkbox"/>
	MA13B2	TABLE ARMOIRE PORTES COULISSANTES 2 COTÉS	130x70x90				<input type="checkbox"/>
	MA14B2	TABLE ARMOIRE PORTES COULISSANTES 2 COTÉS	140x70x90				<input type="checkbox"/>
	MA15B2	TABLE ARMOIRE PORTES COULISSANTES 2 COTÉS	150x70x90				<input type="checkbox"/>
	MA16B2	TABLE ARMOIRE PORTES COULISSANTES 2 COTÉS	160x70x90				<input type="checkbox"/>
	MA17B2	TABLE ARMOIRE PORTES COULISSANTES 2 COTÉS	170x70x90				<input type="checkbox"/>
	MA18B2	TABLE ARMOIRE PORTES COULISSANTES 2 COTÉS	180x70x90				<input type="checkbox"/>
	MA19B2	TABLE ARMOIRE PORTES COULISSANTES 2 COTÉS	190x70x90				<input type="checkbox"/>
	MA20B2	TABLE ARMOIRE PORTES COULISSANTES 2 COTÉS	200x70x90				<input type="checkbox"/>
	MA21B2	TABLE ARMOIRE PORTES COULISSANTES 2 COTÉS	210x70x90				<input type="checkbox"/>
MA22B2	TABLE ARMOIRE PORTES COULISSANTES 2 COTÉS	220x70x90				<input type="checkbox"/>	
	MA10A1E	TABLE ARMOIRE CHAUDE AVEC DOSSERET ARRIÈRE ET PORTES COULISSANTES	100x70x100	2	230V 1N~ / 50 ÷ 60Hz		<input type="checkbox"/>
	MA11A1E	TABLE ARMOIRE CHAUDE AVEC DOSSERET ARRIÈRE ET PORTES COULISSANTES	110x70x100	2	230V 1N~ / 50 ÷ 60Hz		<input type="checkbox"/>
	MA12A1E	TABLE ARMOIRE CHAUDE AVEC DOSSERET ARRIÈRE ET PORTES COULISSANTES	120x70x100	2	230V 1N~ / 50 ÷ 60Hz		<input type="checkbox"/>

MOD.	DESCRIPTION					
	MA13A1E TABLE ARMOIRE CHAUDE AVEC DOSSERET ARRIÈRE ET PORTES COULISSANTES	130x70x100	2	230V 1N~ / 50 ÷ 60Hz	<input type="checkbox"/>	
	MA14A1E TABLE ARMOIRE CHAUDE AVEC DOSSERET ARRIÈRE ET PORTES COULISSANTES	140x70x100	2	230V 1N~ / 50 ÷ 60Hz	<input type="checkbox"/>	
	MA15A1E TABLE ARMOIRE CHAUDE AVEC DOSSERET ARRIÈRE ET PORTES COULISSANTES	150x70x100	2	230V 1N~ / 50 ÷ 60Hz	<input type="checkbox"/>	
	MA16A1E TABLE ARMOIRE CHAUDE AVEC DOSSERET ARRIÈRE ET PORTES COULISSANTES	160x70x100	2	230V 1N~ / 50 ÷ 60Hz	<input type="checkbox"/>	
	MA17A1E TABLE ARMOIRE CHAUDE AVEC DOSSERET ARRIÈRE ET PORTES COULISSANTES	170x70x100	2	230V 1N~ / 50 ÷ 60Hz	<input type="checkbox"/>	
	MA18A1E TABLE ARMOIRE CHAUDE AVEC DOSSERET ARRIÈRE ET PORTES COULISSANTES	180x70x100	2	230V 1N~ / 50 ÷ 60Hz	<input type="checkbox"/>	
	MA19A1E TABLE ARMOIRE CHAUDE AVEC DOSSERET ARRIÈRE ET PORTES COULISSANTES	190x70x100	2	230V 1N~ / 50 ÷ 60Hz	<input type="checkbox"/>	
	MA20A1E TABLE ARMOIRE CHAUDE AVEC DOSSERET ARRIÈRE ET PORTES COULISSANTES	200x70x100	2	230V 1N~ / 50 ÷ 60Hz	<input type="checkbox"/>	
	MA10B1E TABLE ARMOIRE CHAUDE PORTES COULISSANTES	100x70x90	2	230V 1N~ / 50 ÷ 60Hz	<input type="checkbox"/>	
	MA11B1E TABLE ARMOIRE CHAUDE PORTES COULISSANTES	110x70x90	2	230V 1N~ / 50 ÷ 60Hz	<input type="checkbox"/>	
	MA12B1E TABLE ARMOIRE CHAUDE PORTES COULISSANTES	120x70x90	2	230V 1N~ / 50 ÷ 60Hz	<input type="checkbox"/>	
	MA13B1E TABLE ARMOIRE CHAUDE PORTES COULISSANTES	130x70x90	2	230V 1N~ / 50 ÷ 60Hz	<input type="checkbox"/>	
	MA14B1E TABLE ARMOIRE CHAUDE PORTES COULISSANTES	140x70x90	2	230V 1N~ / 50 ÷ 60Hz	<input type="checkbox"/>	
	MA15B1E TABLE ARMOIRE CHAUDE PORTES COULISSANTES	150x70x90	2	230V 1N~ / 50 ÷ 60Hz	<input type="checkbox"/>	
	MA16B1E TABLE ARMOIRE CHAUDE PORTES COULISSANTES	160x70x90	2	230V 1N~ / 50 ÷ 60Hz	<input type="checkbox"/>	
	MA17B1E TABLE ARMOIRE CHAUDE PORTES COULISSANTES	170x70x90	2	230V 1N~ / 50 ÷ 60Hz	<input type="checkbox"/>	
	MA18B1E TABLE ARMOIRE CHAUDE PORTES COULISSANTES	180x70x90	2	230V 1N~ / 50 ÷ 60Hz	<input type="checkbox"/>	
	MA19B1E TABLE ARMOIRE CHAUDE PORTES COULISSANTES	190x70x90	2	230V 1N~ / 50 ÷ 60Hz	<input type="checkbox"/>	
	MA20B1E TABLE ARMOIRE CHAUDE PORTES COULISSANTES	200x70x90	2	230V 1N~ / 50 ÷ 60Hz	<input type="checkbox"/>	
	MA10B2E TABLE ARMOIRE CHAUDE PORTES COULISSANTES 2 COTÉS	100x70x90	2	230V 1N~ / 50 ÷ 60Hz	<input type="checkbox"/>	
	MA11B2E TABLE ARMOIRE CHAUDE PORTES COULISSANTES 2 COTÉS	110x70x90	2	230V 1N~ / 50 ÷ 60Hz	<input type="checkbox"/>	
	MA12B2E TABLE ARMOIRE CHAUDE PORTES COULISSANTES 2 COTÉS	120x70x90	2	230V 1N~ / 50 ÷ 60Hz	<input type="checkbox"/>	
	MA13B2E TABLE ARMOIRE CHAUDE PORTES COULISSANTES 2 COTÉS	130x70x90	2	230V 1N~ / 50 ÷ 60Hz	<input type="checkbox"/>	

	MOD.	DESCRIPTION					€
	MA14B2E	TABLE ARMOIRE CHAUDE PORTES COULISSANTES 2 COTÉS	140x70x90	2	230V 1N~ / 50 ÷ 60Hz		<input type="checkbox"/>
	MA15B2E	TABLE ARMOIRE CHAUDE PORTES COULISSANTES 2 COTÉS	150x70x90	2	230V 1N~ / 50 ÷ 60Hz		<input type="checkbox"/>
	MA16B2E	TABLE ARMOIRE CHAUDE PORTES COULISSANTES 2 COTÉS	160x70x90	2	230V 1N~ / 50 ÷ 60Hz		<input type="checkbox"/>
	MA17B2E	TABLE ARMOIRE CHAUDE PORTES COULISSANTES 2 COTÉS	170x70x90	2	230V 1N~ / 50 ÷ 60Hz		<input type="checkbox"/>
	MA18B2E	TABLE ARMOIRE CHAUDE PORTES COULISSANTES 2 COTÉS	180x70x90	2	230V 1N~ / 50 ÷ 60Hz		<input type="checkbox"/>
	MA19B2E	TABLE ARMOIRE CHAUDE PORTES COULISSANTES 2 COTÉS	190x70x90	2	230V 1N~ / 50 ÷ 60Hz		<input type="checkbox"/>
	MA20B2E	TABLE ARMOIRE CHAUDE PORTES COULISSANTES 2 COTÉS	200x70x90	2	230V 1N~ / 50 ÷ 60Hz		<input type="checkbox"/>























ACCESSOIRES

	MOD.	DESCRIPTION					€
	KRP90	KIT 4 ROUES PIVOTANTES DONT 2 AVEC FREIN	34x34x17				<input type="checkbox"/>

PREPARATION MASTER 700

MEUBLES EN ANGLE, TIROIRS ET TRÉMIES

Structure avec côtés, arrière, portes, fond et plan de travail en acier inoxydable AISI 304 finition satinée, pieds réglables en acier inoxydable.

	MOD.	DESCRIPTION					€
	MAC04A4	TABLE ARMOIRE 4 TIROIRS AVEC DOSSERET ARRIÈRE	40x70x100				
	MAC04B4	TABLE ARMOIRE 4 TIROIRS	40x70x90				
	MAC04A1	TABLE ARMOIRE 1 GRAND TIROIR AVEC DOSSERET ARRIÈRE	40x70x100				
	MAC04B1	TABLE ARMOIRE 1 GRAND TIROIR	40x70x90				
	MAC04A2	TABLE ARMOIRE 2 TIROIRS AVEC DOSSERET ARRIÈRE	40x70x100				
	MAC04B2	TABLE ARMOIRE 2 TIROIRS	40x70x90				
	MAT04A	TABLE ARMOIRE TRÉMIE AVEC DOSSERET ARRIÈRE	40x70x100				
	MAT04B	TABLE ARMOIRE TRÉMIE	40x70x90				
	MAB04A	TABLE ARMOIRE AVEC DOSSERET ARRIÈRE PORTE BATTANTE	40x70x100				

	MOD.	DESCRIPTION					€
	MAB04B	TABLE ARMOIRE AVEC PORTE BATTANTE	40x70x90				
	MAABA	TABLE ARMOIRE D'ANGLE AVEC DOSSERET ARRIERE ET PORTE BATTANTE	98,5x98,5x100				
	MAABB	TABLE ARMOIRE BASSE EN ANGLE AVEC PORTE BATTANTE	98,5x98,5x90				





ACCESSOIRES

	MOD.	DESCRIPTION					€
	KRP90	KIT 4 ROUES PIVOTANTES DONT 2 AVEC FREIN	34x34x17				





PREPARATION MASTER 700

ARMOIRES DE RANGEMENT VAISSELLES AVEC PORTES COULISSANTES

Structure autoportante avec côtes, arrière, portes fond et étagères intermédiaires en tôle d'acier inox AISI 304 satinée et plié a froid. Portes coulissantes à double paroi. Pieds réglables en inox. ...C: utile au rangement des paniers lave-vaisselle.

	MOD.	DESCRIPTION					€
	M12AP	ARMOIRE DE RANGEMENT VAISSELLE, PORTES COULISSANTES	120x70x90				<input type="checkbox"/>
	M14AP	ARMOIRE DE RANGEMENT VAISSELLE, PORTES COULISSANTES	140x70x170				<input type="checkbox"/>
	M16APC	ARMOIRE RANGEMENT VAISSELLE-PANIER, PORTES COULISSANTES	160x70x170				<input type="checkbox"/>
	M20AP	ARMOIRE DE RANGEMENT VAISSELLE, PORTES COULISSANTES	200x70x170				<input type="checkbox"/>





ACCESSOIRES





	MOD.	DESCRIPTION					€
	KRP90	KIT 4 ROUES PIVOTANTES DONT 2 AVEC FREIN	34x34x17				<input type="checkbox"/>







PREPARATION MASTER 700





SYSTÈME DE PLAN UNIQUE





Plan de travail en acier inoxydable AISI 304 finition satinée, épaisseur 12/10 mm, hauteur 54 mm. Dossieret arrière de 100 mm. Panneau insonorisant, hydrofuge et ignifugé. Plan de travail conçu pour accueillir des soubassement bas, des trémies, des tiroirs et des banques réfrigérées.

	MOD.	DESCRIPTION					€
	M110UB	PLAN UNIQUE 110 CM	110x70x5,4				<input type="checkbox"/>
	M115UB	PLAN UNIQUE 115 CM	115x70x5,4				<input type="checkbox"/>
	M120UB	PLAN UNIQUE 120 CM	120x70x5,4				<input type="checkbox"/>
	M125UB	PLAN UNIQUE 125 CM	125x70x5,4				<input type="checkbox"/>
	M130UB	PLAN UNIQUE 130 CM	130x70x5,4				<input type="checkbox"/>
	M135UB	PLAN UNIQUE 135 CM	135x70x5,4				<input type="checkbox"/>
	M140UB	PLAN UNIQUE 140 CM	140x70x5,4				<input type="checkbox"/>
	M145UB	PLAN UNIQUE 145 CM	145x70x5,4				<input type="checkbox"/>
	M150UB	PLAN UNIQUE 150 CM	150x70x5,4				<input type="checkbox"/>
	M155UB	PLAN UNIQUE 155 CM	155x70x5,4				<input type="checkbox"/>
	M160UB	PLAN UNIQUE 160 CM	160x70x5,4				<input type="checkbox"/>
	M165UB	PLAN UNIQUE 165 CM	165x70x5,4				<input type="checkbox"/>
	M170UB	PLAN UNIQUE 170 CM	170x70x5,4				<input type="checkbox"/>
	M175UB	PLAN UNIQUE 175 CM	175x70x5,4				<input type="checkbox"/>
	M180UB	PLAN UNIQUE 180 CM	180x70x5,4				<input type="checkbox"/>
	M185UB	PLAN UNIQUE 185 CM	185x70x5,4				<input type="checkbox"/>
M190UB	PLAN UNIQUE 190 CM	190x70x5,4				<input type="checkbox"/>	
M195UB	PLAN UNIQUE 195 CM	195x70x5,4				<input type="checkbox"/>	
M200UB	PLAN UNIQUE 200 CM	200x70x5,4				<input type="checkbox"/>	























	MOD.	DESCRIPTION	   	€
	M205UB	PLAN UNIQUE 205 CM	205x70x5,4	<input type="checkbox"/>
	M210UB	PLAN UNIQUE 210 CM	210x70x5,4	<input type="checkbox"/>
	M215UB	PLAN UNIQUE 215 CM	215x70x5,4	<input type="checkbox"/>
	M220UB	PLAN UNIQUE 220 CM	220x70x5,4	<input type="checkbox"/>
	M225UB	PLAN UNIQUE 225 CM	225x70x5,4	<input type="checkbox"/>
	M230UB	PLAN UNIQUE 230 CM	230x70x5,4	<input type="checkbox"/>
	M235UB	PLAN UNIQUE 235 CM	235x70x5,4	<input type="checkbox"/>
	M240UB	PLAN UNIQUE 240 CM	240x70x5,4	<input type="checkbox"/>
	M245UB	PLAN UNIQUE 245 CM	245x70x5,4	<input type="checkbox"/>
	M250UB	PLAN UNIQUE 250 CM	250x70x5,4	<input type="checkbox"/>
	M255UB	PLAN UNIQUE 255 CM	255x70x5,4	<input type="checkbox"/>
	M260UB	PLAN UNIQUE 260 CM	260x70x5,4	<input type="checkbox"/>
	M265UB	PLAN UNIQUE 265 CM	265x70x5,4	<input type="checkbox"/>
	M270UB	PLAN UNIQUE 270 CM	270x70x5,4	<input type="checkbox"/>
	M275UB	PLAN UNIQUE 275 CM	275x70x5,4	<input type="checkbox"/>
	M280UB	PLAN UNIQUE 280 CM	280x70x5,4	<input type="checkbox"/>
	M285UB	PLAN UNIQUE 285 CM	285x70x5,4	<input type="checkbox"/>
	M290UB	PLAN UNIQUE 290 CM	290x70x5,4	<input type="checkbox"/>
	M295UB	PLAN UNIQUE 295 CM	295x70x5,4	<input type="checkbox"/>
	M300UB	PLAN UNIQUE 300 CM	300x70x5,4	<input type="checkbox"/>
M305UB	PLAN UNIQUE 305 CM	305x70x5,4	<input type="checkbox"/>	
M310UB	PLAN UNIQUE 310 CM	310x70x5,4	<input type="checkbox"/>	
M315UB	PLAN UNIQUE 315 CM	315x70x5,4	<input type="checkbox"/>	

	MOD.	DESCRIPTION					€
	M320UB	PLAN UNIQUE 320 CM	320x70x5,4				<input type="checkbox"/>
	M325UB	PLAN UNIQUE 325 CM	325x70x5,4				<input type="checkbox"/>
	M330UB	PLAN UNIQUE 330 CM	330x70x5,4				<input type="checkbox"/>
	M335UB	PLAN UNIQUE 335 CM	335x70x5,4				<input type="checkbox"/>
	M340UB	PLAN UNIQUE 340 CM	340x70x5,4				<input type="checkbox"/>
	M345UB	PLAN UNIQUE 345 CM	345x70x5,4				<input type="checkbox"/>
	M350UB	PLAN UNIQUE 350 CM	350x70x5,4				<input type="checkbox"/>
	M355UB	PLAN UNIQUE 355 CM	355x70x5,4				<input type="checkbox"/>
	M360UB	PLAN UNIQUE 360 CM	360x70x5,4				<input type="checkbox"/>
	M365UB	PLAN UNIQUE 365 CM	365x70x5,4				<input type="checkbox"/>
	M370UB	PLAN UNIQUE 370 CM	370x70x5,4				<input type="checkbox"/>
	M375UB	PLAN UNIQUE 375 CM	375x70x5,4				<input type="checkbox"/>
	M380UB	PLAN UNIQUE 380 CM	380x70x5,4				<input type="checkbox"/>
	M110UA	PLAN UNIQUE AVEC DOSSERET ARRIÈRE 110 CM	110x70x15,4				<input type="checkbox"/>
	M115UA	PLAN UNIQUE AVEC DOSSERET ARRIÈRE 115 CM	115x70x15,4				<input type="checkbox"/>
	M120UA	PLAN UNIQUE AVEC DOSSERET ARRIÈRE 120 CM	120x70x15,4				<input type="checkbox"/>
	M125UA	PLAN UNIQUE AVEC DOSSERET ARRIÈRE 125 CM	125x70x15,4				<input type="checkbox"/>
	M130UA	PLAN UNIQUE AVEC DOSSERET ARRIÈRE 130 CM	130x70x15,4				<input type="checkbox"/>
	M135UA	PLAN UNIQUE AVEC DOSSERET ARRIÈRE 135 CM	135x70x15,4				<input type="checkbox"/>
	M140UA	PLAN UNIQUE AVEC DOSSERET ARRIÈRE 140 CM	140x70x15,4				<input type="checkbox"/>
	M145UA	PLAN UNIQUE AVEC DOSSERET ARRIÈRE 145 CM	145x70x15,4				<input type="checkbox"/>
	M150UA	PLAN UNIQUE AVEC DOSSERET ARRIÈRE 150 CM	150x70x15,4				<input type="checkbox"/>
	M155UA	PLAN UNIQUE AVEC DOSSERET ARRIÈRE 155 CM	155x70x15,4				<input type="checkbox"/>

MOD.	DESCRIPTION	   	€
 M160UA	PLAN UNIQUE AVEC DOSSERET ARRIÈRE 160 CM	160x70x15,4	<input type="checkbox"/>
M165UA	PLAN UNIQUE AVEC DOSSERET ARRIÈRE 165 CM	165x70x15,4	<input type="checkbox"/>
M170UA	PLAN UNIQUE AVEC DOSSERET ARRIÈRE 170 CM	170x70x15,4	<input type="checkbox"/>
M175UA	PLAN UNIQUE AVEC DOSSERET ARRIÈRE 175 CM	175x70x15,4	<input type="checkbox"/>
M180UA	PLAN UNIQUE AVEC DOSSERET ARRIÈRE 180 CM	180x70x15,4	<input type="checkbox"/>
M185UA	PLAN UNIQUE AVEC DOSSERET ARRIÈRE 185 CM	185x70x15,4	<input type="checkbox"/>
M190UA	PLAN UNIQUE AVEC DOSSERET ARRIÈRE 190 CM	190x70x15,4	<input type="checkbox"/>
M195UA	PLAN UNIQUE AVEC DOSSERET ARRIÈRE 195 CM	195x70x15,4	<input type="checkbox"/>
M200UA	PLAN UNIQUE AVEC DOSSERET ARRIÈRE 200 CM	200x70x15,4	<input type="checkbox"/>
M205UA	PLAN UNIQUE AVEC DOSSERET ARRIÈRE 205 CM	205x70x15,4	<input type="checkbox"/>
M210UA	PLAN UNIQUE AVEC DOSSERET ARRIÈRE 210 CM	210x70x15,4	<input type="checkbox"/>
M215UA	PLAN UNIQUE AVEC DOSSERET ARRIÈRE 215 CM	215x70x15,4	<input type="checkbox"/>
M220UA	PLAN UNIQUE AVEC DOSSERET ARRIÈRE 220 CM	220x70x15,4	<input type="checkbox"/>
M225UA	PLAN UNIQUE AVEC DOSSERET ARRIÈRE 225 CM	225x70x15,4	<input type="checkbox"/>
M230UA	PLAN UNIQUE AVEC DOSSERET ARRIÈRE 230 CM	230x70x15,4	<input type="checkbox"/>
M235UA	PLAN UNIQUE AVEC DOSSERET ARRIÈRE 235 CM	235x70x15,4	<input type="checkbox"/>
M240UA	PLAN UNIQUE AVEC DOSSERET ARRIÈRE 240 CM	240x70x15,4	<input type="checkbox"/>
M245UA	PLAN UNIQUE AVEC DOSSERET ARRIÈRE 245 CM	245x70x15,4	<input type="checkbox"/>
M250UA	PLAN UNIQUE AVEC DOSSERET ARRIÈRE 250 CM	250x70x15,4	<input type="checkbox"/>
M255UA	PLAN UNIQUE AVEC DOSSERET ARRIÈRE 255 CM	255x70x15,4	<input type="checkbox"/>
M260UA	PLAN UNIQUE AVEC DOSSERET ARRIÈRE 260 CM	260x70x15,4	<input type="checkbox"/>
M265UA	PLAN UNIQUE AVEC DOSSERET ARRIÈRE 265 CM	265x70x15,4	<input type="checkbox"/>
M270UA	PLAN UNIQUE AVEC DOSSERET ARRIÈRE 270 CM	270x70x15,4	<input type="checkbox"/>

MOD.	DESCRIPTION	   	€
 M275UA	PLAN UNIQUE AVEC DOSSERET ARRIÈRE 275 CM	275x70x15,4	<input type="checkbox"/>
M280UA	PLAN UNIQUE AVEC DOSSERET ARRIÈRE 280 CM	280x70x15,4	<input type="checkbox"/>
M285UA	PLAN UNIQUE AVEC DOSSERET ARRIÈRE 285 CM	285x70x15,4	<input type="checkbox"/>
M290UA	PLAN UNIQUE AVEC DOSSERET ARRIÈRE 290 CM	290x70x15,4	<input type="checkbox"/>
M295UA	PLAN UNIQUE AVEC DOSSERET ARRIÈRE 295 CM	295x70x15,4	<input type="checkbox"/>
M300UA	PLAN UNIQUE AVEC DOSSERET ARRIÈRE 300 CM	300x70x15,4	<input type="checkbox"/>
M305UA	PLAN UNIQUE AVEC DOSSERET ARRIÈRE 305 CM	305x70x15,4	<input type="checkbox"/>
M310UA	PLAN UNIQUE AVEC DOSSERET ARRIÈRE 310 CM	310x70x15,4	<input type="checkbox"/>
M315UA	PLAN UNIQUE AVEC DOSSERET ARRIÈRE 315 CM	315x70x15,4	<input type="checkbox"/>
M320UA	PLAN UNIQUE AVEC DOSSERET ARRIÈRE 320 CM	320x70x15,4	<input type="checkbox"/>
M325UA	PLAN UNIQUE AVEC DOSSERET ARRIÈRE 325 CM	325x70x15,4	<input type="checkbox"/>
M330UA	PLAN UNIQUE AVEC DOSSERET ARRIÈRE 330 CM	330x70x15,4	<input type="checkbox"/>
M335UA	PLAN UNIQUE AVEC DOSSERET ARRIÈRE 335 CM	335x70x15,4	<input type="checkbox"/>
M340UA	PLAN UNIQUE AVEC DOSSERET ARRIÈRE 340 CM	340x70x15,4	<input type="checkbox"/>
M345UA	PLAN UNIQUE AVEC DOSSERET ARRIÈRE 345 CM	345x70x15,4	<input type="checkbox"/>
M350UA	PLAN UNIQUE AVEC DOSSERET ARRIÈRE 350 CM	350x70x15,4	<input type="checkbox"/>
M355UA	PLAN UNIQUE AVEC DOSSERET ARRIÈRE 355 CM	355x70x15,4	<input type="checkbox"/>
M360UA	PLAN UNIQUE AVEC DOSSERET ARRIÈRE 360 CM	360x70x15,4	<input type="checkbox"/>
M365UA	PLAN UNIQUE AVEC DOSSERET ARRIÈRE 365 CM	365x70x15,4	<input type="checkbox"/>
M370UA	PLAN UNIQUE AVEC DOSSERET ARRIÈRE 370 CM	370x70x15,4	<input type="checkbox"/>
M375UA	PLAN UNIQUE AVEC DOSSERET ARRIÈRE 375 CM	375x70x15,4	<input type="checkbox"/>
M380UA	PLAN UNIQUE AVEC DOSSERET ARRIÈRE 380 CM	380x70x15,4	<input type="checkbox"/>

ACCESSOIRES

	MOD.	DESCRIPTION					€
	MPUALTD	DOSSERET LATÉRAL DROIT	70x10x10				
	MPUALTS	DOSSERET LATÉRAL GAUCHE	70x10x10				
	PUV4050	CUVE À SOUDER CM 40X50X25	50x25x40				
	PUV5050	CUVE À SOUDER CM 50X50X25	50x25x50				
	PUV8050	CUVE À SOUDER CM 80X50X25	80x50x25				
	PUVI4050	CUVE À SOUDER CM 40X50X25 AVEC RETENUE	40x25x50				
	PUVI5050	CUVE À SOUDER CM 50X50X25 AVEC RETENUE	50x25x50				
		PUINV13	CUVE CM 50X50X25 H AVEC RÉSERVOIR 136X64 CM À SOUDER	50x25x50			
	MPUSL05	SOUBASSEMENT ARMOIRE SANS PLAN AVEC TIROIR	50x70x86				
	MPUSL06	SOUBASSEMENT ARMOIRE SANS PLAN AVEC TIROIR	60x70x86				
	MPUSL07	SOUBASSEMENT ARMOIRE SANS PLAN AVEC TIROIR	70x70x86				
	MPUSL08	SOUBASSEMENT ARMOIRE SANS PLAN AVEC PORTE BATTANTE	80x70x86				
	MPUSL09	SOUBASSEMENT ARMOIRE SANS PLAN AVEC PORTE BATTANTE	90x70x86				
	MPUSL10	SOUBASSEMENT ARMOIRE SANS PLAN AVEC PORTE BATTANTE	100x70x86				

PREPARATION MASTER 700

SOUBASSEMENTS POUR PLANS DE TRAVAIL UNIQUE

Structure autoportante en acier inoxydable AISI 304 finition satinée, portes coulissantes à double paroi, étagère intermédiaire renforcée en oméga, pieds réglables en acier inoxydable. Sans dessus. ...1: ouverture sur une face. ...2: ouverture sur deux faces. ...E : chauffage ventilé avec thermostat +30/+90°C. MZC... Plinthe







pour armoires. Pour des autres dimensions ou pour les plinthes latérales en présence de banques réfrigérées placées à droite ou à gauche de la composition à plan unique, veuillez contacter l'entreprise.













MOD.	DESCRIPTION		
MA10Z1	TABLE ARMOIRE SANS DESSUS PORTES COULISSANTES	100x70x86	<input type="checkbox"/>
MA11Z1	TABLE ARMOIRE SANS DESSUS PORTES COULISSANTES	110x70x86	<input type="checkbox"/>
MA12Z1	TABLE ARMOIRE SANS DESSUS PORTES COULISSANTES	120x70x86	<input type="checkbox"/>
MA13Z1	TABLE ARMOIRE SANS DESSUS PORTES COULISSANTES	130x70x86	<input type="checkbox"/>
MA14Z1	TABLE ARMOIRE SANS DESSUS PORTES COULISSANTES	140x70x86	<input type="checkbox"/>
MA15Z1	TABLE ARMOIRE SANS DESSUS PORTES COULISSANTES	150x70x86	<input type="checkbox"/>
MA16Z1	TABLE ARMOIRE SANS DESSUS PORTES COULISSANTES	160x70x86	<input type="checkbox"/>
MA17Z1	TABLE ARMOIRE SANS DESSUS PORTES COULISSANTES	170x70x86	<input type="checkbox"/>
MA18Z1	TABLE ARMOIRE SANS DESSUS PORTES COULISSANTES	180x70x86	<input type="checkbox"/>
MA19Z1	TABLE ARMOIRE SANS DESSUS PORTES COULISSANTES	190x70x86	<input type="checkbox"/>
MA20Z1	TABLE ARMOIRE SANS DESSUS PORTES COULISSANTES	200x70x86	<input type="checkbox"/>



MA10Z2	TABLE ARMOIRE SANS DESSUS PORTES COULISSANTES 2 COTÉS	100x70x86	<input type="checkbox"/>
MA11Z2	TABLE ARMOIRE SANS DESSUS PORTES COULISSANTES 2 COTÉS	110x70x86	<input type="checkbox"/>
MA12Z2	TABLE ARMOIRE SANS DESSUS PORTES COULISSANTES 2 COTÉS	120x70x86	<input type="checkbox"/>
MA14Z2	TABLE ARMOIRE SANS DESSUS PORTES COULISSANTES 2 COTÉS	140x70x86	<input type="checkbox"/>
MA13Z2	TABLE ARMOIRE SANS DESSUS PORTES COULISSANTES 2 COTÉS	130x70x86	<input type="checkbox"/>
MA15Z2	TABLE ARMOIRE SANS DESSUS PORTES COULISSANTES 2 COTÉS	150x70x86	<input type="checkbox"/>
MA16Z2	TABLE ARMOIRE SANS DESSUS PORTES COULISSANTES 2 COTÉS	160x70x86	<input type="checkbox"/>
MA17Z2	TABLE ARMOIRE SANS DESSUS PORTES COULISSANTES 2 COTÉS	170x70x86	<input type="checkbox"/>









	MOD.	DESCRIPTION					€
	MA18Z2	TABLE ARMOIRE SANS DESSUS PORTES COULISSANTES 2 COTÉS	180x70x86				
	MA19Z2	TABLE ARMOIRE SANS DESSUS PORTES COULISSANTES 2 COTÉS	190x70x86				
	MA20Z2	TABLE ARMOIRE SANS DESSUS PORTES COULISSANTES 2 COTÉS	200x70x86				
	MA10Z1E	TABLE ARMOIRE CHAUDE SANS DESSUS PORTES COULISSANTES	100x70x86	2	230V 1N~ / 50 ÷ 60Hz		
	MA11Z1E	TABLE ARMOIRE CHAUDE SANS DESSUS PORTES COULISSANTES	110x70x86	2	230V 1N~ / 50 ÷ 60Hz		
	MA12Z1E	TABLE ARMOIRE CHAUDE SANS DESSUS PORTES COULISSANTES	120x70x86	2	230V 1N~ / 50 ÷ 60Hz		
	MA13Z1E	TABLE ARMOIRE CHAUDE SANS DESSUS PORTES COULISSANTES	130x70x86	2	230V 1N~ / 50 ÷ 60Hz		
	MA14Z1E	TABLE ARMOIRE CHAUDE SANS DESSUS PORTES COULISSANTES	140x70x86	2	230V 1N~ / 50 ÷ 60Hz		
	MA15Z1E	TABLE ARMOIRE CHAUDE SANS DESSUS PORTES COULISSANTES	150x70x86	2	230V 1N~ / 50 ÷ 60Hz		
	MA16Z1E	TABLE ARMOIRE CHAUDE SANS DESSUS PORTES COULISSANTES	160x70x86	2	230V 1N~ / 50 ÷ 60Hz		
	MA17Z1E	TABLE ARMOIRE CHAUDE SANS DESSUS PORTES COULISSANTES	170x70x86	2	230V 1N~ / 50 ÷ 60Hz		
	MA18Z1E	TABLE ARMOIRE CHAUDE SANS DESSUS PORTES COULISSANTES	180x70x86	2	230V 1N~ / 50 ÷ 60Hz		
	MA19Z1E	TABLE ARMOIRE CHAUDE SANS DESSUS PORTES COULISSANTES	190x70x86	2	230V 1N~ / 50 ÷ 60Hz		
	MA10Z2E	TABLE ARMOIRE CHAUDE SANS DESSUS PORTES COULISSANTES 2 COTÉS	100x70x86	2	230V 1N~ / 50 ÷ 60Hz		
	MA11Z2E	TABLE ARMOIRE CHAUDE SANS DESSUS PORTES COULISSANTES 2 COTÉS	110x70x86	2	230V 1N~ / 50 ÷ 60Hz		
	MA12Z2E	TABLE ARMOIRE CHAUDE SANS DESSUS PORTES COULISSANTES 2 COTÉS	120x70x86	2	230V 1N~ / 50 ÷ 60Hz		
	MA13Z2E	TABLE ARMOIRE CHAUDE SANS DESSUS PORTES COULISSANTES 2 COTÉS	130x70x86	2	230V 1N~ / 50 ÷ 60Hz		
	MA14Z2E	TABLE ARMOIRE CHAUDE SANS DESSUS PORTES COULISSANTES 2 COTÉS	140x70x86	2	230V 1N~ / 50 ÷ 60Hz		
	MA15Z2E	TABLE ARMOIRE CHAUDE SANS DESSUS PORTES COULISSANTES 2 COTÉS	150x70x86	2	230V 1N~ / 50 ÷ 60Hz		
	MA16Z2E	TABLE ARMOIRE CHAUDE SANS DESSUS PORTES COULISSANTES 2 COTÉS	160x70x86	2	230V 1N~ / 50 ÷ 60Hz		
	MA17Z2E	TABLE ARMOIRE CHAUDE SANS DESSUS PORTES COULISSANTES 2 COTÉS	170x70x86	2	230V 1N~ / 50 ÷ 60Hz		
	MA18Z2E	TABLE ARMOIRE CHAUDE SANS DESSUS PORTES COULISSANTES 2 COTÉS	180x70x86	2	230V 1N~ / 50 ÷ 60Hz		

	MOD.	DESCRIPTION					€
	MA19Z2E	TABLE ARMOIRE CHAUDE SANS DESSUS PORTES COULISSANTES 2 COTÉS	190x70x86	2	230V 1N~ / 50 ÷ 60Hz		<input type="checkbox"/>
	MA20Z2E	TABLE ARMOIRE CHAUDE SANS DESSUS PORTES COULISSANTES 2 COTÉS	200x70x86	2	230V 1N~ / 50 ÷ 60Hz		<input type="checkbox"/>
	MAC04Z1	TABLE ARMOIRE SANS DESSUS 1 GRAND TIROIR	40x70x86				<input type="checkbox"/>
	MAC04Z2	TABLE ARMOIRE SANS DESSUS 2 TIROIRS	40x70x86				<input type="checkbox"/>
	MAC04Z4	TABLE ARMOIRE SANS DESSUS 4 TIROIRS	40x70x86				<input type="checkbox"/>
	MAT04Z	TABLE ARMOIRE TRÉMIE SANS DESSUS	40x70x86				<input type="checkbox"/>
	MAB04Z	TABLE ARMOIRE SANS DESSUS AVEC PORTE BATTANTE	40x70x86				<input type="checkbox"/>

ACCESSOIRES

	MOD.	DESCRIPTION					€
	KRP90	KIT 4 ROUES PIVOTANTES DONT 2 AVEC FREIN	34x34x17				<input type="checkbox"/>
	MZC120	PLINTE FAÇADE 120 CM	120x3x14				<input type="checkbox"/>
	MZC130	PLINTE FAÇADE 130 CM	130x3x14				<input type="checkbox"/>
	MZC150	PLINTE FAÇADE 150 CM	150x3x14				<input type="checkbox"/>
	MZC160	PLINTE FAÇADE 160 CM	160x3x14				<input type="checkbox"/>
	MZC170	PLINTE FAÇADE 170 CM	170x3x14				<input type="checkbox"/>
	MZC180	PLINTE FAÇADE 180 CM	180x3x14				<input type="checkbox"/>







ACCESSOIRES





	MOD.	DESCRIPTION					€
	MZC190	PLINTE FAÇADE 190 CM	190x3x14				
	MZC200	PLINTE FAÇADE 200 CM	200x3x14				
	MZCL70	PLINTHES LATÉRALES	2x70x14				

PREPARATION MASTER 600





TABLES DE TRAVAIL

Plan de travail en acier inoxydable AISI 304 satiné, épaisseur 12/10 mm, hauteur 54 mm, panneau insonorisant, hydrofuge et ignifuge, adapté à des charges maximales de 150 kg/m² garanties par l'appui au sol de pieds tubulaires en acier inoxydable Ø 50 mm. M...A: dessus de travail avec dossier arrière h 100mm. M...B: dessus sans dossier arrière.











	MOD.	DESCRIPTION					€
	M06TJB	TABLE AVEC PLAN DE TRAVAIL 60 CM	60x60x90				<input type="checkbox"/>
	M07TJB	TABLE AVEC PLAN DE TRAVAIL 70 CM	70x60x90				<input type="checkbox"/>
	M08TJB	TABLE AVEC PLAN DE TRAVAIL 80 CM	80x60x90				<input type="checkbox"/>
	M09TJB	TABLE AVEC PLAN DE TRAVAIL 90 CM	90x60x90				<input type="checkbox"/>
	M10TJB	TABLE AVEC PLAN DE TRAVAIL 100 CM	100x60x90				<input type="checkbox"/>
	M11TJB	TABLE AVEC PLAN DE TRAVAIL 110 CM	110x60x90				<input type="checkbox"/>
	M12TJB	TABLE AVEC PLAN DE TRAVAIL 120 CM	120x60x90				<input type="checkbox"/>
	M13TJB	TABLE AVEC PLAN DE TRAVAIL 130 CM	130x60x90				<input type="checkbox"/>
	M14TJB	TABLE AVEC PLAN DE TRAVAIL 140 CM	140x60x90				<input type="checkbox"/>
	M15TJB	TABLE AVEC PLAN DE TRAVAIL 150 CM	150x60x90				<input type="checkbox"/>
	M16TJB	TABLE AVEC PLAN DE TRAVAIL 160 CM	160x60x90				<input type="checkbox"/>
	M17TJB	TABLE AVEC PLAN DE TRAVAIL 170 CM	170x60x90				<input type="checkbox"/>
	M18TJB	TABLE AVEC PLAN DE TRAVAIL 180 CM	180x60x90				<input type="checkbox"/>
M19TJB	TABLE AVEC PLAN DE TRAVAIL 190 CM	190x60x90				<input type="checkbox"/>	
M20TJB	TABLE AVEC PLAN DE TRAVAIL 200 CM	200x60x90				<input type="checkbox"/>	
	M06TJA	TABLE AVEC PLAN DE TRAVAIL ET DOSSERET ARRIÈRE 60 CM	60x60x100				<input type="checkbox"/>
	M07TJA	TABLE AVEC PLAN DE TRAVAIL ET DOSSERET ARRIÈRE 70 CM	70x60x100				<input type="checkbox"/>
	M08TJA	TABLE AVEC PLAN DE TRAVAIL ET DOSSERET ARRIÈRE 80 CM	80x60x100				<input type="checkbox"/>
	M09TJA	TABLE AVEC PLAN DE TRAVAIL ET DOSSERET ARRIÈRE 90 CM	90x60x100				<input type="checkbox"/>

	MOD.	DESCRIPTION					€
	M10TJA	TABLE AVEC PLAN DE TRAVAIL ET DOSSERET ARRIÈRE 100 CM	100x60x100				<input type="checkbox"/>
	M11TJA	TABLE AVEC PLAN DE TRAVAIL ET DOSSERET ARRIÈRE 110 CM	110x60x100				<input type="checkbox"/>
	M12TJA	TABLE AVEC PLAN DE TRAVAIL ET DOSSERET ARRIÈRE 120 CM	120x60x100				<input type="checkbox"/>
	M13TJA	TABLE AVEC PLAN DE TRAVAIL ET DOSSERET ARRIÈRE 130 CM	130x60x100				<input type="checkbox"/>
	M14TJA	TABLE AVEC PLAN DE TRAVAIL ET DOSSERET ARRIÈRE 140 CM	140x60x100				<input type="checkbox"/>
	M15TJA	TABLE AVEC PLAN DE TRAVAIL ET DOSSERET ARRIÈRE 150 CM	150x60x100				<input type="checkbox"/>
	M16TJA	TABLE AVEC PLAN DE TRAVAIL ET DOSSERET ARRIÈRE 160 CM	160x60x100				<input type="checkbox"/>
	M17TJA	TABLE AVEC PLAN DE TRAVAIL ET DOSSERET ARRIÈRE 170 CM	170x60x100				<input type="checkbox"/>
	M18TJA	TABLE AVEC PLAN DE TRAVAIL ET DOSSERET ARRIÈRE 180 CM	180x60x100				<input type="checkbox"/>
	M19TJA	TABLE AVEC PLAN DE TRAVAIL ET DOSSERET ARRIÈRE 190 CM	190x60x100				<input type="checkbox"/>
	M20TJA	TABLE AVEC PLAN DE TRAVAIL ET DOSSERET ARRIÈRE 200 CM	200x60x100				<input type="checkbox"/>

ACCESSOIRES

	MOD.	DESCRIPTION					€
	M06RFJ	ÉTAGÈRE INFÉRIEURE POUR TABLE DE TRAVAIL DE 60 CM	48,4x48,4x3,7				<input type="checkbox"/>
	M07RFJ	ÉTAGÈRE INFÉRIEURE POUR TABLE DE TRAVAIL DE 70 CM	58,4x48,4x3,7				<input type="checkbox"/>
	M08RFJ	ÉTAGÈRE INFÉRIEURE POUR TABLE DE TRAVAIL DE 80 CM	68,4x48,4x3,7				<input type="checkbox"/>
	M09RFJ	ÉTAGÈRE INFÉRIEURE POUR TABLE DE TRAVAIL DE 90 CM	78,4x48,4x3,7				<input type="checkbox"/>
	M10RFJ	ÉTAGÈRE INFÉRIEURE POUR TABLE DE TRAVAIL DE 100 CM	88,4x48,4x3,7				<input type="checkbox"/>
	M11RFJ	ÉTAGÈRE INFÉRIEURE POUR TABLE DE TRAVAIL DE 100 CM	98,4x48,4x3,7				<input type="checkbox"/>
	M12RFJ	ÉTAGÈRE INFÉRIEURE POUR TABLE DE TRAVAIL DE 120 CM	108,4x48,4x3,7				<input type="checkbox"/>
	M13RFJ	ÉTAGÈRE INFÉRIEURE POUR TABLE DE TRAVAIL DE 130 CM	118,4x48,4x3,7				<input type="checkbox"/>
	M14RFJ	ÉTAGÈRE INFÉRIEURE POUR TABLE DE TRAVAIL DE 140 CM	128,4x48,4x3,7				<input type="checkbox"/>
	M15RFJ	ÉTAGÈRE INFÉRIEURE POUR TABLE DE TRAVAIL DE 150 CM	138,4x48,4x3,7				<input type="checkbox"/>

ACCESSOIRES















	MOD.	DESCRIPTION					€
	M16RFJ	ÉTAGÈRE INFÉRIEURE POUR TABLE DE TRAVAIL DE 160 CM	144,2x48,2x5				<input type="checkbox"/>
	M17RFJ	ÉTAGÈRE INFÉRIEURE POUR TABLE DE TRAVAIL DE 170 CM	154,2x48,2x5				<input type="checkbox"/>
	M18RFJ	ÉTAGÈRE INFÉRIEURE POUR TABLE DE TRAVAIL DE 180 CM	164,2x48,2x5				<input type="checkbox"/>
	M19RFJ	ÉTAGÈRE INFÉRIEURE POUR TABLE DE TRAVAIL DE 190 CM	174,2x48,2x5				<input type="checkbox"/>
	M20RFJ	ÉTAGÈRE INFÉRIEURE POUR TABLE DE TRAVAIL DE 200 CM	184,2x48,2x5				<input type="checkbox"/>
	M04CJ111	TIROIR EMPILABLE EN ACIER INOX GN 1/1	40x60x21				<input type="checkbox"/>
	M04CJ411	4 TIROIRS EN ACIER INOXYDABLE GN 1/1	40x60x62				<input type="checkbox"/>
	MPAJA	TABLE DE TRAVAIL SUSPENDUE EN ANGLE	88,6x88,6x145				<input type="checkbox"/>
	MGPA A	PIED POUR TABLE DE TRAVAIL SUSPENDUE EN ANGLE	20x80x14				<input type="checkbox"/>
	KRP4GG	KIT 4 ROULETTES, 2 AVEC FREINS ET PIEDS DE TABLE	20x20x80				<input type="checkbox"/>
	KRP6GG	KIT 6 ROULETTES, 2 AVEC FREINS ET PIEDS DE TABLE	20x20x80				<input type="checkbox"/>











PREPARATION MASTER 600

PLONGES SUR PIEDS ET SUR ARMOIRE







Dessus avec dossier arrière embouti h 100 mm, en acier inoxydable AISI 304 satiné. Cuve emboutie, insérée dans le dessus par soudure continue étanche. Pieds réglables. Plonge sur pieds avec habillage de façade inox AISI 304, pieds tubulaires Ø 50 mm en inox AISI 304. Armoire en acier inoxydable AISI 304 sans arrière avec portes coulissantes à

double paroi et étagère inférieure ; fond en tôle d'acier inoxydable AISI 304 finition satinée avec renfort oméga. Espacement 180 mm entre sol et étagère. Plonge de 80 cm avec portes battantes.

	MOD.	DESCRIPTION					
	M08LJ16	PLONGE SUR PIEDS 1 BAC CM 50X40X25H	80x60x100				<input type="checkbox"/>
	M10LJ24	PLONGE SUR PIEDS 2 BACS CM 40X40X25H	100x60x100				<input type="checkbox"/>
	M12LJ14D	PLONGE SUR PIEDS 1 BAC CM 40X40X25H EGOUTTOIR DROIT	120x60x100				<input type="checkbox"/>
	M12LJ14S	PLONGE SUR PIEDS 1 BAC CM 40X40X25H EGOUTTOIR GAUCHE	120x60x100				<input type="checkbox"/>
	M14LJ24D	PLONGE SUR PLACARD 2 BACS CM 40X40X25H EGOUTTOIR DROIT	140x60x100				<input type="checkbox"/>
	M14LJ24S	PLONGE SUR PLACARD 2 BACS CM 40X40X25H EGOUTTOIR GAUCHE	140x60x100				<input type="checkbox"/>
	M16LJ24D	PLONGE SUR PIEDS 2 BACS CM 40X40X25H EGOUTTOIR DROIT	160x60x100				<input type="checkbox"/>
	M16LJ24S	PLONGE SUR PIEDS 2 BACS CM 40X40X25H EGOUTTOIR GAUCHE	160x60x100				<input type="checkbox"/>
	MLAJ1024	PLONGE SUR PLACARD 2 BACS CM 40X40X25H	100x60x100				<input type="checkbox"/>

MOD.	DESCRIPTION					€
	MLAJ121D PLONGE SUR PLACARD 1 BAC CM 40X40X25H EGOUTTOIR DROIT	120x60x100				
	MLAJ121S PLONGE SUR PLACARD 1 BAC CM 40X40X25H EGOUTTOIR GAUCHE	120x60x100				
	MLAJ142D PLONGE SUR PLACARD 2 BACS CM 40X40X25H EGOUTTOIR DROIT	140x60x100				
	MLAJ142S PLONGE SUR PLACARD 2 BACS CM 40X40X25H EGOUTTOIR GAUCHE	140x60x100				
	MLAJ162D PLONGE SUR PLACARD 2 BACS CM 40X40X25H EGOUTTOIR DROIT	160x60x100				
	MLAJ162S PLONGE SUR PLACARD 2 BACS CM 40X40X25H EGOUTTOIR GAUCHE	160x60x100				

ACCESSOIRES

MOD.	DESCRIPTION					€
	M08RFJL ÉTAGÈRE INFÉRIEURE POUR PLONGE DE 80 CM	77,1x44,2x5				
	M10RFJL ÉTAGÈRE INFÉRIEURE POUR PLONGE DE 100 CM	97,1x44,2x5				
	M12RFJL ÉTAGÈRE INFÉRIEURE POUR PLONGE DE 120 CM	117,1x44,2x5				
	M14RFJL ÉTAGÈRE INFÉRIEURE POUR PLONGE DE 140 CM	137,1x44,2x5				
	M16RFJL ÉTAGÈRE INFÉRIEURE POUR PLONGE DE 160 CM	157,1x44,2x5				
	CEM ROBINET MELANGEUR EAU CHAUDE/FROIDE	40x20x8				
	CEG ROBINET MELANGEUR COUDÉ EAU CHAUDE/FROIDE ROBINET	40x20x8				

ACCESSOIRES









	MOD.	DESCRIPTION					€
	DF	DOUCHETTE FIXE	12x40x105				<input type="checkbox"/>
	EAP	GROUP MELANGEUR EAU, A COMMANDE A PEDALE À FIXER SUR L'ETAGERE BASSE	70x20x20				<input type="checkbox"/>
	MKSV25P	KIT SIPHON+ BONDE POUR BACS H 25 CM	20x30x10				<input type="checkbox"/>











PREPARATION MASTER 600

TABLES ARMOIRES







Structure autoportante en acier inoxydable AISI 304 finition satinée, portes coulissantes à double paroi, étagère intermédiaire renforcée en oméga, pieds réglables en acier inoxydable. Plan de travail en acier inoxydable AISI 304 finition satinée, hauteur 54 mm, épaisseur 12/10. ...B : Plan de travail sans dossier arrière. ...A :

Plan de travail avec dossier arrière h 100mm. MZC... Zoccolatura per armadi. Per zoccolatura posizionata in presenza di basi refrigerate, contattare l'azienda. ...E : chauffage ventilé avec thermostat +30/+90°C.







	MOD.	DESCRIPTION					
	MAJ10B	TABLE ARMOIRE AVEC PORTES COULISSANTES	100x60x90				<input type="checkbox"/>
	MAJ12B	TABLE ARMOIRE AVEC PORTES COULISSANTES	120x60x90				<input type="checkbox"/>
	MAJ14B	TABLE ARMOIRE AVEC PORTES COULISSANTES	140x60x90				<input type="checkbox"/>
	MAJ16B	TABLE ARMOIRE AVEC PORTES COULISSANTES	160x60x90				<input type="checkbox"/>
	MAJ18B	TABLE ARMOIRE AVEC PORTES COULISSANTES	180x60x90				<input type="checkbox"/>
	MAJ20B	TABLE ARMOIRE AVEC PORTES COULISSANTES	200x60x90				<input type="checkbox"/>
	MAJ10A	TABLE ARMOIRE AVEC DOSSERET ARRIÈRE PORTES COULISSANTES	100x60x100				<input type="checkbox"/>
	MAJ12A	TABLE ARMOIRE AVEC DOSSERET ARRIÈRE PORTES COULISSANTES	120x60x100				<input type="checkbox"/>
	MAJ14A	TABLE ARMOIRE AVEC DOSSERET ARRIÈRE PORTES COULISSANTES	140x60x100				<input type="checkbox"/>
	MAJ16A	TABLE ARMOIRE AVEC DOSSERET ARRIÈRE PORTES COULISSANTES	160x60x100				<input type="checkbox"/>
	MAJ18A	TABLE ARMOIRE AVEC DOSSERET ARRIÈRE PORTES COULISSANTES	180x60x100				<input type="checkbox"/>
	MAJ20A	TABLE ARMOIRE AVEC DOSSERET ARRIÈRE PORTES COULISSANTES	200x60x100				<input type="checkbox"/>
	MAJ12BE	TABLE ARMOIRE CHAUDE PORTES COULISSANTES	120x60x90			230V 1N~ / 50 ÷ 60Hz	<input type="checkbox"/>
	MAJ14BE	TABLE ARMOIRE CHAUDE PORTES COULISSANTES	140x60x90			230V 1N~ / 50 ÷ 60Hz	<input type="checkbox"/>
	MAJ16BE	TABLE ARMOIRE CHAUDE PORTES COULISSANTES	160x60x90			230V 1N~ / 50 ÷ 60Hz	<input type="checkbox"/>
	MAJ18BE	TABLE ARMOIRE CHAUDE PORTES COULISSANTES	180x60x90			230V 1N~ / 50 ÷ 60Hz	<input type="checkbox"/>
	MAJ20BE	TABLE ARMOIRE CHAUDE PORTES COULISSANTES	200x60x90			230V 1N~ / 50 ÷ 60Hz	<input type="checkbox"/>
	MAJ12AE	TABLE ARMOIRE CHAUDE AVEC DOSSERET ARRIÈRE ET PORTES COULISSANTES	120x60x100			230V 1N~ / 50 ÷ 60Hz	<input type="checkbox"/>
	MAJ14AE	TABLE ARMOIRE CHAUDE AVEC DOSSERET ARRIÈRE ET PORTES COULISSANTES	140x60x100			230V 1N~ / 50 ÷ 60Hz	<input type="checkbox"/>

	MOD.	DESCRIPTION					€
	MAJ16AE	TABLE ARMOIRE CHAUDE AVEC DOSSERET ARRIÈRE ET PORTES COULISSANTES	160x60x100			230V 1N~ / 50 ÷ 60Hz	<input type="checkbox"/>
	MAJ18AE	TABLE ARMOIRE CHAUDE AVEC DOSSERET ARRIÈRE ET PORTES COULISSANTES	180x60x100			230V 1N~ / 50 ÷ 60Hz	<input type="checkbox"/>
	MAJ20AE	TABLE ARMOIRE CHAUDE AVEC DOSSERET ARRIÈRE ET PORTES COULISSANTES	200x60x100			230V 1N~ / 50 ÷ 60Hz	<input type="checkbox"/>
	MAAJBB	TABLE ARMOIRE BASSE EN ANGLE AVEC PORTE BATTANTE	88,5x88,5x90				<input type="checkbox"/>
	MAAJBA	TABLE ARMOIRE D'ANGLE AVEC DOSSERET ARRIÈRE ET PORTE BATTANTE	88,5x88,5x100				<input type="checkbox"/>
	MACJ04B4	TABLE ARMOIRE 4 TIROIRS	40x60x90				<input type="checkbox"/>
	MACJ04A4	TABLE ARMOIRE 4 TIROIRS AVEC DOSSERET ARRIÈRE	40x60x100				<input type="checkbox"/>
	MATJ04B	TABLE ARMOIRE TRÉMIE	40x60x90				<input type="checkbox"/>
	MATJ04A	TABLE ARMOIRE TRÉMIE AVEC DOSSERET ARRIÈRE	40x60x100				<input type="checkbox"/>

ACCESSOIRES

	MOD.	DESCRIPTION					€
	KRP90	KIT 4 ROUES PIVOTANTES DONT 2 AVEC FREIN	34x34x17				<input type="checkbox"/>
	MZC120	PLINTE FAÇADE 120 CM	120x3x14				<input type="checkbox"/>
	MZC130	PLINTE FAÇADE 130 CM	130x3x14				<input type="checkbox"/>
	MZC150	PLINTE FAÇADE 150 CM	150x3x14				<input type="checkbox"/>

























ACCESSOIRES















	MOD.	DESCRIPTION					€
	MZC160	PLINTHE FAÇADE 160 CM	160x3x14				<input type="checkbox"/>
	MZC170	PLINTHE FAÇADE 170 CM	170x3x14				<input type="checkbox"/>
	MZC180	PLINTHE FAÇADE 180 CM	180x3x14				<input type="checkbox"/>
	MZC190	PLINTHE FAÇADE 190 CM	190x3x14				<input type="checkbox"/>
	MZC200	PLINTHE FAÇADE 200 CM	200x3x14				<input type="checkbox"/>
	MZCL60	PLINTHES LATÉRALES	2x60x14				<input type="checkbox"/>

ÉLÉMENTS COMPLEMENTAIRES

PLACARDS MURAUX

Structure autoportante en acier inox AISI 304, satiné. Angles intérieurs largement rayonnés. Étagère intermédiaire réglable en hauteur. Étagère sans glissières. ...G: version ouverte. ...C: avec portes coulissantes. ...B: avec portes battantes. ...SC: avec portes coulissantes avec étagère barreauté. ...L = éclairage LED inférieur.

	MOD.	DESCRIPTION					€
	M10PG	PLACARD MURAUX OUVERT	100x40x66				
	M12PG	PLACARD MURAUX OUVERT	120x40x66				
	M14PG	PLACARD MURAUX OUVERT	140x40x66				
	M16PG	PLACARD MURAUX OUVERT	160x40x66				
	M12PGL	PLACARD MURAUX OUVERT AVEC ÉCLAIRAGE LED	120x40x66				
	M14PGL	PLACARD MURAUX OUVERT AVEC ÉCLAIRAGE LED	140x40x66				
	M16PGL	PLACARD MURAUX OUVERT AVEC ÉCLAIRAGE LED	160x40x66				
	M10PC	PLACARD MURAL AVEC PORTES COULISSANTES	100x40x66				
	M12PC	PLACARD MURAL AVEC PORTES COULISSANTES	120x40x66				
	M14PC	PLACARD MURAL AVEC PORTES COULISSANTES	140x40x66				
	M16PC	PLACARD MURAL AVEC PORTES COULISSANTES	160x40x66				
	M18PC	PLACARD MURAL AVEC PORTES COULISSANTES	180x40x66				
	M20PC	PLACARD MURAL AVEC PORTES COULISSANTES	200x40x66				
	M14PSC	PLACARD MURAL AVEC ETAGERE BARRAUDEE	140x40x66				
	M12PCL	PLACARD MURAL AVEC PORTES COULISSANTES ET ÉCLAIRAGE LED	120x40x66				
	M14PCL	PLACARD MURAL AVEC PORTES COULISSANTES ET ÉCLAIRAGE LED	140x40x66				
	M16PCL	PLACARD MURAL AVEC PORTES COULISSANTES ET ÉCLAIRAGE LED	160x40x66				

	MOD.	DESCRIPTION					€
	M08PB	PLACARD MURAL AVEC PORTES BATTANTES	80x40x66				
	M12PB	PLACARD MURAL AVEC PORTES BATTANTES	120x40x66				
	M16PB	PLACARD MURAL AVEC PORTES BATTANTES	160x40x66				
	MAPB	PLACARD MURAL EN ANGLE AVEC PORTES BATTANTES	98,5x98,5x66				
	MAPG	PLACARD MURAL EN ANGLE	98,5x98,5x66				

ÉLÉMENTS COMPLEMENTAIRES

ÉTAGÈRES ET RAYONNAGES









ARP...: étagère murale réglable en acier inox AISI 304 avec dossier arrière. MS : étagères complètes avec 4 étagères en acier inoxydable AISI 304 et supports de renfort.

	MOD.	DESCRIPTION					€
	ARP804	ETAGÈRE MURALE EN ACIER INOX AISI304, 80 CM	80x40x5				<input type="checkbox"/>
	ARP1004	ETAGÈRE MURALE EN ACIER INOX AISI304, 100 CM	100x40x5				<input type="checkbox"/>
	ARP1204	ETAGÈRE MURALE EN ACIER INOX AISI304, 120 CM	120x40x5				<input type="checkbox"/>
	ARP1404	ETAGÈRE MURALE EN ACIER INOX AISI304, 140 CM	140x40x5				<input type="checkbox"/>
	ARP1604	ETAGÈRE MURALE EN ACIER INOX AISI304, 160 CM	160x40x5				<input type="checkbox"/>
	ARP1804	ETAGÈRE MURALE EN ACIER INOX AISI304, 180 CM	180x40x5				<input type="checkbox"/>
	MS1250	RAYONNAGE - 4 ÉTAGÈRES	120x55x199				<input type="checkbox"/>
	MS1050	RAYONNAGE - 4 ÉTAGÈRES	100x55x199				<input type="checkbox"/>
	MS1450	RAYONNAGE - 4 ÉTAGÈRES	140x55x199				<input type="checkbox"/>
	MS1650	RAYONNAGE - 4 ÉTAGÈRES	160x55x199				<input type="checkbox"/>
	MS1850	RAYONNAGE - 4 ÉTAGÈRES	180x55x199				<input type="checkbox"/>
	MS2050	RAYONNAGE - 4 ÉTAGÈRES	200x55x199				<input type="checkbox"/>







ÉLÉMENTS COMPLEMENTAIRES

LAVE MAINS

Structure en acier inox satiné. ...G: commande à genou. ...P: commande a pédale.























	MOD.	DESCRIPTION					€
	LMG	LAVE MAINS A FIXER AU MUR, COMMANDE A GENOU	50x50x33				<input type="checkbox"/>
	LMP	LAVE MAINS SUR PLACARD, COMMANDE A PEDALE	50x50x90				<input type="checkbox"/>
	LMSCG	LAVE MAINS SUR PLACARD AVEC STERILISATEUR	47x39x103	2,5		230V 1N~ / 50Hz	<input type="checkbox"/>
	LMSCP	LAVE MAINS SUR PLACARD AVEC STERILISATEUR	62x51x105	2,5		230V 1N~ / 50 ÷ 60Hz	<input type="checkbox"/>
	SC	STERILISATEUR A COUTEAUX MURAL	47x30x65	2,5		230V 1N~ / 50Hz	<input type="checkbox"/>









ACCESSOIRES

	MOD.	DESCRIPTION					€
	DC	DISTRIBUTEUR SERVIETTES PAPIER	30x10x29				<input type="checkbox"/>
	DS	DISTRIBUTEUR DE SAVON LIQUIDE	13x10x19,5				<input type="checkbox"/>
	PLM	SUPPORT MURAL POUR DISTRIBUER SAVON ET SERVIETTES	50x10x50				<input type="checkbox"/>





ÉLÉMENTS COMPLEMENTAIRES

CHARIOTS

	MOD.	DESCRIPTION					€
	C311	CHARIOT AVEC CHÂSSIS POUR 3 BACS GN 1/1	120x65x45				
	CC311	CHARIOT AVEC CUVE POUR 3 BACS GN 1/1	130x70x45				
	CRG2021	CHARIOT 18 NIVEAUX POUR BACS GN 2/1	65x72x171				
	CEM21	CHARIOT POUR BAC AVEC HAUTEUR REGLABLE	97x70x114				
	VCV	BAC MOBILE POUR LEGUMES	88x66x100				
	CMX	CHARIOT DE SERVICE INOX	100x60x80				
	CR2X	CHARIOT DE SERVICE 2 NIVEAUX	100x50x95				
	CR3X	CHARIOT DE SERVICE 3 NIVEAUX	100x50x95				
	CT3GN	CHARIOT CHAUFFANT 3 x GN 1/1	121x64x85		1,8	230V 1N~/50Hz	



	MOD.	DESCRIPTION					€
	CTV20	CHARIOT PORTE PLATEAUX 20 PIECES	95x61x156				
	CTV30	CHARIOT PORTE PLATEAUX 30 PIECES	138x61x156				

ACCESSOIRES

	MOD.	DESCRIPTION					€
	VRBX	BAC POUR BOUTEILLES, INSERABLE DANS MOD.CTV20/30	50x33x8				

ÉLÉMENTS COMPLEMENTAIRES

POUBELLES ET BILLOTS

	MOD.	DESCRIPTION					€
	PCR40	POUBELLE MOBILE OUVERTURE COUVERCLE, 50LT	40x40x60,5				<input type="checkbox"/>
	PCR70	POUBELLE MOBILE OUVERTURE COUVERCLE, 75 LT	45x45x60,5				<input type="checkbox"/>
	PCR40P	POUBELLE MOBILE OUVERTURE COUVERCLE, AVEC PÉDALE, 50 LT	40x40x60,5				<input type="checkbox"/>
	PCR70P	POUBELLE MOBILE OUVERTURE COUVERCLE, AVEC PÉDALE, 75 LT	45x45x60,5				<input type="checkbox"/>
	C4545P	BILLOT A VIANDE	45x45x90				<input type="checkbox"/>
	C5070P	BILLOT A VIANDE	50x70x90				<input type="checkbox"/>

APPAREILS MECANIQUES

Confectionneur, trancheurs, éplucheuses, hachoirs viande, coupe légumes et cutter

Confectionneur sous vide: structure en acier inox AISI 304. Couvercle et cloche transparents en matière plastique à usage alimentaire. Panneau commandes digitale, 9 programmes mémorisables.

Trancheurs: structure en alliage anodisée, lame en acier inox, microcontact de sécurité sur para lame. Complété par aiguiser avec microcontact de sécurité transmission à courroie. Chariot large avec barrière de protection pour les mains.

Eplucheuses: structure en acier inox AISI 304. Couvercle en plexiglas. Surface abrasive in carborundum facile à enlever. Panneau de commandes étanche. Equipée de disque pour pommes de terre et carottes.

Hachoirs viande pour table: avec dispositif de sécurité.

Coupe Légumes: structure et base en aluminium anodisé. Levier presseur et arbre disque en acier inox AISI 304. Fonctionnement monophasé. Une vitesse. Equipé de bac en acier inox, glissière et pelle expulsion.







Cutter: structure extérieur et cuve en acier inox AISI 304. Couvercle transparent en matériau atoxique moulé. Fonctionnement monophasé. Une vitesse. Equipé de moyeu supplémentaire à lames lisses, pelle et pierre à aiguiser.



APPAREILS MECANIQUES

CONFECTIONNEUR SOUS VIDE

...! Pré-équipé pour immission de gaz inerte à usage alimentaire. Bouteille et tube non fournis.

	MOD.	DESCRIPTION					€
	MS1	CONFECTIONNEUR SOUS VIDE 10 MC/HEURE	39x53,5x46,5	0,9	230V 1N~ / 50 ÷ 60Hz		
	MS1I	CONFECTIONNEUR SOUS VIDE 10 MC/HEURE, PRÉ-ÉQUIPÉ POUR IMMISSION DE GAZ INERTE	39x53,5x46	0,9	230V 1N~ / 50 ÷ 60Hz		
	MS2	CONFECTIONNEUR SOUS VIDE 20 MC/HEURE, DISPOSITIF SOFT-AIR	53,9x65,5x50	1,15	230V 1N~ / 50 ÷ 60Hz		
	MS2I	CONFECTIONNEUR SOUS VIDE 20 MC/HEURE, PRÉ-ÉQUIPÉ POUR IMMISSION DE GAZ INERTE	53,9x65,5x50	1,15	230V 1N~ / 50 ÷ 60Hz		
	MS4	CONFECTIONNEUR SOUS VIDE 40 MC/HEURE, DISPOSITIF SOFT-AIR	77x72,5x103	1,5	400V 3N~ 50 ÷60 Hz		
	MS4I	CONFECTIONNEUR SOUS VIDE 40 MC/HEURE, PRÉ-ÉQUIPÉ POUR IMMISSION DE GAZ INERTE	77x72,5x103	1,5	400V 3N~ 50 ÷60 Hz		









ACCESSOIRES

	MOD.	DESCRIPTION					€
	CMS2	CHARIOT AVEC ETAGERE ET ROULETTES POUR MS2/MS2I	53,9x53,9x53				

APPAREILS MECANIQUES





TRANCHEURS

Standard: fonctionnement triphasé. ...M:
Fonctionnement monophasé.

	MOD.	DESCRIPTION					
	AFC30S	MACHINE A COUPER VIANDE LAME VERTICALE Ø 300 MM	66x54x44	0,24	400V 3~ / 50Hz		<input type="checkbox"/>
	AFC35	MACHINE A COUPER VIANDE LAME VERTICALE Ø 350 MM	78x66x53	0,3	400V 3~ / 50Hz		<input type="checkbox"/>
	AFTE300	MACHINE A COUPER CHARCUTERIE LAME INCLINÉE Ø 300 MM COMPACTE	51x56x43	0,23	400V 3~ / 50Hz		<input type="checkbox"/>
	AFT30S	MACHINE A COUPER CHARCUTERIE LAME INCLINÉE Ø 300 MM	68x58x43	0,24	400V 3~ / 50Hz		<input type="checkbox"/>
	AFT33S	TRANCHEUR LAME INCLINÉE Ø 330 MM	72x58x45	0,28	400V 3~ / 50Hz		<input type="checkbox"/>
	AFT35	MACHINE A COUPER CHARCUTERIE LAME INCLINÉE Ø 350 MM	82x63x48	0,3	400V 3~ / 50Hz		<input type="checkbox"/>
	AFT30VS	TRANCHEUR LAME VERTICALE Ø 300 MM	68x52x49	0,24	400V 3~ / 50Hz		<input type="checkbox"/>
	AFT35VS	TRANCHEUR LAME VERTICALE Ø 350 MM	78x62x58	0,3	400V 3~ / 50Hz		<input type="checkbox"/>

APPAREILS MECANIQUES

EPLUCHEUSES

	MOD.	DESCRIPTION					€
	PK5I	EPLUCHEUSE SUR CHASSIS CAPACITÉ 5 KG	41x61x80	0,27	400V 3N~/ 50Hz		
	PK10I	EPLUCHEUSE SUR CHASSIS CAPACITÉ 10 KG	45x69x95	0,75	400V 3N~/ 50Hz		
	PK20I	EPLUCHEUSE SUR CHASSIS CAPACITÉ 20 KG	51x74x108	1,15	400V 3N~/ 50Hz		
	PK30I	EPLUCHEUSE SUR CHASSIS CAPACITÉ 30 KG	51x73x114	1,15	400V 3N~/ 50Hz		







APPAREILS MECANIQUES

HACHOIRS VIANDE

TG...: Base, structure et râpe en fusion d'aluminium polie. Roulement en aluminium anodisé avec microcontact de sécurité. TG12: Groupe à hacher en fonte.





TG12XE: Groupe à hacher en inox extractible. TC22S: Base, structure et râpe en fusion d'aluminium polie avec plaque d'acier inox AISI 304. Coteau hache-viande en acier inox AISI 304.

Fouloir pousse-viande en PVC. Trémie pour la viande en acier inox AISI 304.









	MOD.	DESCRIPTION					€
	TG12	HACHOIR VIANDE ET RAPE POUR TABLE, BOUCHE 12	67x24x43	0,75	400V 3~ / 50Hz		
	TG12XE	HACHOIR VIANDE ET RAPE POUR TABLE, BOUCHE 12	67x24x43	0,75	400V 3~ / 50Hz		
	TC22S	HACHE VIANDE POUR TABLE, ATTACHÉE 22	27x37x44	1,1	400V 3~ / 50Hz		

APPAREILS MECANIQUES







COUPE LEGUMES

	MOD.	DESCRIPTION					€
	STV	COUPE LEGUMES	28x51x46	0,515	230V 1N~/50Hz		<input type="checkbox"/>

ACCESSOIRES

	MOD.	DESCRIPTION					€
	KIT5	KIT DE 5 PLATINES POUR COUPE LEGUMES STV					<input type="checkbox"/>
	DFE1	DISQUE POUR LAMELLES 1 MM					<input type="checkbox"/>
	DFE2	DISQUE POUR LAMELLES 2 MM					<input type="checkbox"/>
	DFE3	DISQUE POUR LAMELLES 3 MM					<input type="checkbox"/>
	DFE4	DISQUE POUR LAMELLES 4 MM					<input type="checkbox"/>
	DFE5	DISQUE POUR LAMELLES 5 MM					<input type="checkbox"/>
	DFE8	DISQUE POUR LAMELLES 8 MM					<input type="checkbox"/>
	DFE10	DISQUE POUR LAMELLES 10 MM					<input type="checkbox"/>
	DFE14	DISQUE POUR LAMELLES 14 MM					<input type="checkbox"/>
	DG	DISQUE POUR RAPER					<input type="checkbox"/>
	DB44	DISQUE POUR BATONETS 4x4 MM	20x20x10				<input type="checkbox"/>
	DB66	DISQUE POUR BATONETS 6x6 MM					<input type="checkbox"/>
	DB88	DISQUE POUR BATONETS 8x8 MM					<input type="checkbox"/>
	DB1010	DISQUE POUR BATONETS 10x10 MM					<input type="checkbox"/>





ACCESSOIRES

	MOD.	DESCRIPTION					€
	DSF2	DISQUE POUR JULIENNE 2 MM					<input type="checkbox"/>
	DSF3	DISQUE POUR JULIENNE 3 MM					<input type="checkbox"/>
	DSF4	DISQUE POUR JULIENNE 4 MM					<input type="checkbox"/>
	DSF7	DISQUE POUR JULIENNE 7 MM					<input type="checkbox"/>
	DSF9	DISQUE POUR JULIENNE 9 MM					<input type="checkbox"/>
	GC88	DISQUE GRILLE POUR CUBES 8x8 MM					<input type="checkbox"/>
	GC1010	DISQUE GRILLE POUR CUBES 10x10 MM					<input type="checkbox"/>
	GC1414	DISQUE GRILLE POUR CUBES 14x14 MM	18x18x2				<input type="checkbox"/>
	GC2020	DISQUE GRILLE POUR CUBES 20x20 MM					<input type="checkbox"/>









APPAREILS MECANIQUES

CUTTER

VV: Variateur de vitesse (1100-2600 RPM).

	MOD.	DESCRIPTION					€
	SC4	CUTTER CAPACITÉ 4 L	38x32x27	0,35	230V 1N~/50Hz		<input type="checkbox"/>
	SC6	CUTTER CAPACITÉ 6 L	38x32x32	0,35	230V 1N~/50Hz		<input type="checkbox"/>
	SC9VV	CUTTER CAPACITÉ 9 L	47x33x40	0,7	230V 1N~/50Hz		<input type="checkbox"/>

ACCESSOIRES

	MOD.	DESCRIPTION					€
	MSLD4	MOYEAU SUPPLEMENTAIRE A LAMES DENTEES POUR CUTTER 4 L					<input type="checkbox"/>
	MSLD6	MOYEAU SUPPLEMENTAIRE A LAMES DENTEES POUR CUTTER 6 L					<input type="checkbox"/>
	MSLD9	MOYEAU SUPPLEMENTAIRE A LAMES DENTEES POUR CUTTER 9 L					<input type="checkbox"/>
	MSLF4	MOYEAU SUPPLEMENTAIRE A LAMES TROUEES POUR CUTTER 4 L					<input type="checkbox"/>
	MSLF6	MOYEAU SUPPLEMENTAIRE A LAMES TROUEES POUR CUTTER 6 L					<input type="checkbox"/>
	MSLF9	MOYEAU SUPPLEMENTAIRE A LAMES TROUEES POUR CUTTER 9 L					<input type="checkbox"/>
	MSP4	MOYEAU SUPPLEMENTAIRE POUR SAUCE "PESTO" POUR CUTTER 4 L					<input type="checkbox"/>
	MSP6	MOYEAU SUPPLEMENTAIRE POUR SAUCE "PESTO" POUR CUTTER 6 L					<input type="checkbox"/>
	MSP9	MOYEAU SUPPLEMENTAIRE POUR SAUCE "PESTO" POUR CUTTER 9 L					<input type="checkbox"/>
	MSLO4	MOYEAU SUPPLEMENTAIRE LAMES ONDULEES POUR CUTTER 4 L					<input type="checkbox"/>
	MSLO6	MOYEAU SUPPLEMENTAIRE LAMES ONDULEES POUR CUTTER 6 L					<input type="checkbox"/>
	MSLO9	MOYEAU SUPPLEMENTAIRE LAMES ONDULEES POUR CUTTER 9 L					<input type="checkbox"/>